

KIDDER

DESIGN TECHNOLOGY
AND SCIENCE EDUCATION

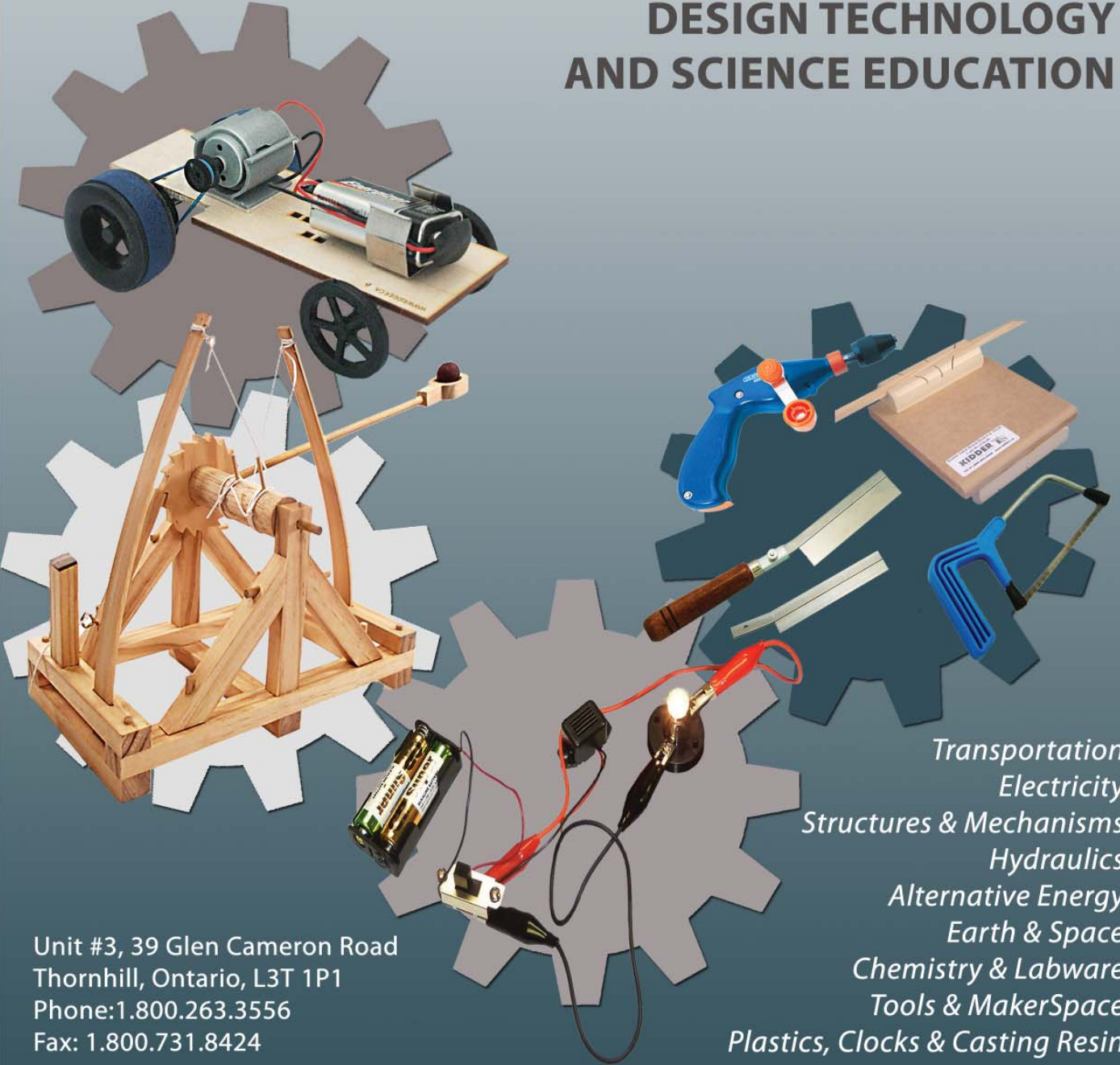

*Transportation
Electricity
Structures & Mechanisms
Hydraulics
Alternative Energy
Earth & Space
Chemistry & Labware
Tools & MakerSpace
Plastics, Clocks & Casting Resin
...and more!*

Unit #3, 39 Glen Cameron Road
Thornhill, Ontario, L3T 1P1
Phone: 1.800.263.3556
Fax: 1.800.731.8424

  
Cat# 80-5946-00

www.kidder.ca

SHORT SUMMARY INDEX

TRANSPORTATION Pg. 4-13

MECHANISMS Pulleys & Gears Pg. 14 & 15

ELECTRICITY Pg. 16-20

ALTERNATIVE ENERGY Pg. 21 & 22

MAGNETICS Pg. 23 & 24

STRUCTURES Wood Building Materials Pg. 25-27

TOOLS & ACCESSORIES Pg. 28-32

MAKERSPACE Pg. 33-34

SAFETY Pg. 35

KIDDERAMA DOLLAR STORE! Pg. 36-38

HYDRAULICS/PNEUMATICS Pg. 39 & 40

TEACHERGEEK Pg. 41 & 42

FLIGHT/AEROSPACE Pg. 43-45

EARTH & SPACE Pg. 46

OPTICS Pg. 47

LABWARE & CHEMISTRY Pg. 48 & 49

PHYSICS Forces, Mass & Density Pg. 50

PLASTICS & MANUFACTURING Pg. 51-55

RESOURCE MATERIAL Pg. 56-58

CLOCKS & CRAFT SUPPLIES Pg. 59-69

Balloon Helicopter Kit



Pg. 50

MakerSpace Stations



Pg. 34

WIGGLE-BOTS

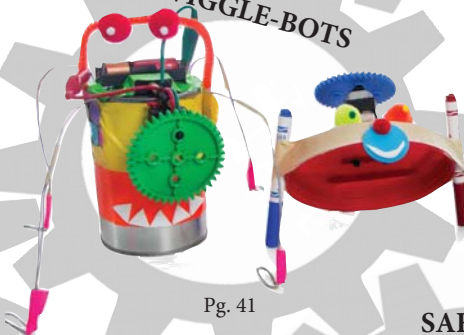

Pg. 41

SAFETY



Pg. 35

TELESCOPES



Pg. 46

connect



Kidder - Design
Technology
& Science Education



@kiddereducation



Kidder Science
Education



info@kidder.ca



Kiddertechd

WWW.KIDDER.CA



Teachers! Kidder uses our Twitter account @kiddereducation as a forum for Science & Tech Teachers to share project ideas, ask questions about Kidder products and post pictures of your students designs/experiments!

If you are in need of a professional quotation please email info@kidder.ca and be sure to include your schools information along with catalog numbers and quantities.

CO2 Dragster Supplies



Also available in Balsa Cat# 19-1014



B



C



D



E



F



G



H



I



J

K) Custom
Cat# 19-P318

L) Stripes & Flames
Cat# 19-P307

M) Nascar
Cat# 19-P317

N) Hot Rod
Cat# 19-P314



A...Bass Body Blanks

The basswood blank has a hole for the cartridge cut out.

It is 30cm x 4cm x 7cm.

CAT# 19-1013 EAQTY 1 \$5.60, 2-5 \$5.00, 20+ \$4.30
CAT# 19-1014 EA (BALSA).....QTY 1 \$7.70 2-5 \$6.85 20+ \$5.95

B...Rear Slicks

These plastic slicks are 40mm in diameter and 16mm thick.

CAT# 19-1016 EAQTY 1 56¢, 2-5 46¢, 6-19 42¢
CAT# 19-54-1016 100/PKG\$30.00
CAT# 19-5426 500/PKG.....\$146.50

C...Front Wheels

These plastic wheels are 33mm in diameter and 5mm thick.

CAT# 19-1015 EAQTY 1 47¢, 2-5 43¢, 6-19 39¢
CAT# 19-54-1015 100/PKG\$22.50
CAT# 19-5425 500/PK.....\$99.50

D...Screw Eyes allows 3mm (1/8") axle as well

Guide your fishing line through the screw eyes which are placed on the bottom of the car.

CAT# 19-1024 25/ PKG\$3.95
CAT# 19-54-1024 100/PKG\$9.35

E...Washers (allows 1/8" axle to fit through it)

Use these washers on axle to hold the wheel in place.

CAT# 19-1021 10/PKG80¢
CAT# 19-54-1021 200/PKG.....\$11.00

F...SteelAxles

These axles are 63mm x 3mm (2.5" x 1/8)

CAT# 19-1023 2/PKG50¢
CAT# 19-54-1023 100/PKG.....\$11.00

G...305mm (12") Steel Axles 3mm (1/8") diam (can be cut to length)

CAT# 19-1028 6/PKG\$4.20

H...Straws 203mm (8") length for 3mm (1/8") axle

Run the axle through these straws to use as a bearing.

CAT# 19-1022 10/PKG45¢
CAT# 19-54-1022 50/PKG90¢

I...CO2 Cartridges 8gm (18mm diam)

CAT# 19-1018 EA.....QTY 1 \$1.02, 2-5 95¢, 6-19 87¢
CAT# 19-54-1018 100/PKG\$72.00
CAT# 19-5429 250/PKG\$170.00

J...Filament Line for C02 Cars 183 m, 3.6kg, 200 yd

CAT# 19-1005FLN.....\$9.00

K-N..Dragster Decals

Dry Transfer Decals are the fastest and easiest way to customize a derby racer. Colourful stripes, flames, numbers, and graphics apply easily in seconds. They are high-quality rub-on decals that can be applied around contours and over textures. With Dry Transfer Decals there is no clear film around the edges of decals. (Size 102 x 127mm)

CAT# 19-P318 CUSTOM.....\$10.40
CAT# 19-P307 STRIPES & FLAMES.....\$10.50
CAT# 19-P317 NASCAR\$10.50
CAT# 19-P314 HOT ROD\$10.50

A...Dragster 50 Student Class Pack

This class pack comes with all the supplies to make 50 dragsters. It comes with 100 cartridges for 2 shots per car.

- 100 x Rear Racing WheelsCat# 19-1016
 - 100 x Front Dragster Wheels.....Cat# 19-1015
 - 100 x CO2 Cartridges.....Cat# 19-1018
 - 50 x Steel Axles 2/pkg.....Cat# 19-1023
 - 20 x Brass Washers 10/pkg.....Cat# 19-1021
 - 5 x Straws 10/pkg.....Cat# 19-1022
 - 50 x 12" Basswood Blanks.....Cat# 19-1013
 - 4 x Screw Eyes 25/pkg.....Cat# 19-1024
 - 1 x Idea Sheet.....Cat# 80-5766
- CAT# 19-5420.....\$360.00 (WITH BASSWOOD BLANKS)**
CAT# 19-5422.....\$155.00 (NO WOOD)

B... CO2 Dragster Module

This is a proven learning package which has been re-worked to add a new wrinkle or two to this age-old favourite. Students will design, build, test, and modify CO2 car designs. New testing and racing tips include fluid-mapping and rain gutter racing.

CAT# 80-5736-00.....\$25.00

C....Single Dragster Kits

This kit includes everything you need to make one dragster. Kit includes basswood blank, wheels, axles, washers and Co2 cartridge.

CAT# 19-1010QTY 1 \$9.30 6+ \$8.10

D.... Start Pin Assemblies (Make your own launcher)

These start pin assemblies have a powerful spring action to impel the cartridge. You can make your own launcher using these assemblies and a piece of plywood.

CAT# 19-1006\$43.65

CAT# 19-1006-RP (REPLACEMENT PINS).....\$18.10

E....CO2 Hotshot Launcher

This unit is very portable (11 3/4" x 10" plate). It does not have any dangerous exposed springs or tension hammer. It is supplied with a fishing line. It is the most durable launcher available.

CAT# 19-1005-KE 2-LANE.....\$634.00

CAT# 19-1005PIN (REPLACEMENT PINS).....\$63.00 EA

Fishing Line 100m Spool

CAT# 19-1005FLN\$9.00

F....CO2 Dragster Motion Timer

Measures speed and time—use with Cars, Boats & Maglevs. The features included; input distance in feet or meters, portable, easy to use, no computer required, 2 line LCD display, infrared start/finish gates,

* Input Distance in Feet or Meters and Results are Displayed in Time, MPH or KPH, memory (it remembers prior competitions).

CAT# 19-1003.....\$496.00

G....Electronic Scale

This easy to use 5 kg electronic scale has a mode button that allows you to measure in grams, pounds and ounces along with a blue back light that allows for easy digital reading.

Capacity 5 kg/11.05 lbs in 1 g/1/8 oz increments.

4AA batteries included.

CAT# 98-1265-00.....\$97.50

H. CO2 Blank Sanding Stick

This Sanding Stick makes sanding curves and angles on dragsters a smooth task. Sanding surface is 5" long and tapers from 1" to 1/2". The sandpaper wraps around the stick, reducing the need to turn it. Make sandpaper sheets to fit with the included templates.

CAT# 50-159.....\$9.95 (2+ \$8.90)

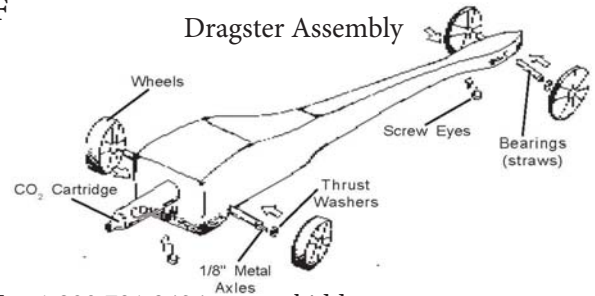
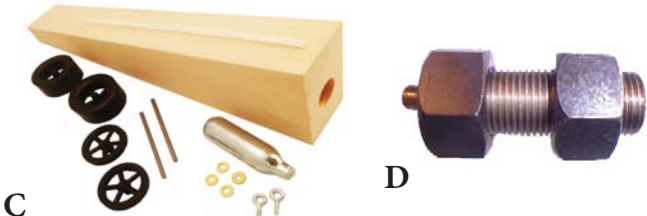

Toll Free 1.800.263.3556 • Toll Free Fax 1.800.731.8424 • www.kidder.ca

Prices are subject to change without notice

Co2 Eliminator Dragster Launcher & Co2 Eliminator Parts

This 2-lane race car system uses compressed air instead of Co2 cartridges

Co2 Eliminator 10 Student Class Pack



Cat# 19-5435...\$58.00

Cat# 19-5436...\$17.90*

*Without Wood

Kit includes:

- 20 front wheels
- 20 slicks
- 10 blanks
- 8 straws
- 20 screw eyes
- 40 washers
- 20 axles



A
8" x 1.5" x 2.75"



B



C



D



E



F



G

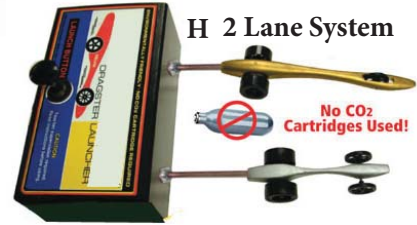

H 2 Lane System

Cat# 19-1505...\$480.00

Advantages:

- no wasted cartridges-students can repeatedly test during design,modification & finishing stages
- construct smaller cars- use less wood for vehicle design because there is no need to a lot room for the cartridge.
- use standard wheels
- more vehicle shapes are possible
- requires compressed air source.

Fig	Cat #	Description	Qty 1	2-5	6-19	20-49	50+
A	19-1513	Basswood 8" x 1.5" x 2.75"	\$4.45	\$4.25	\$3.95	\$3.80	\$3.70
B	19-1523	Axles 2" x 1/8"/Pkg	\$24	\$22	\$21	-	-
C	19-1015	Front Wheel ea	\$47	\$43	\$39	\$31	\$25
D	19-1016	Rear Wheel ea	\$56	\$46	\$42	\$38	\$33
E	19-1021	Brass Washers 10/Pkg	\$80	\$75	\$70	\$60	\$55
F	19-1024	Screw Eyes 1/4" 25/Pkg	\$3.95	\$3.30			-
G	19-1022	Straws 10/Pkg (axle bearing)	\$45	\$30	\$29	\$27	\$26
H	19-1505	Eliminator Drag Launcher	\$480.00	-	-	-	-
I	19-5435	10 Class Pack with Wood	\$58.00	-	-	-	-
J	19-5436	10 Class Pack with no Wood	\$17.90	-	-	-	-

Formula 1 Cars

What is the F1 in Schools CAD/CAM Design Challenge?



F1 IN SCHOOLS is a unique technology challenge that involves the construction of a 1/20th-scale CO2 Formula One (F1) racing car out of balsa wood using Computer Aided Design and Manufacturing technologies and a CNC router. This standards-based challenge seeks to raise the profile of engineering among young people and give them access to the latest technology in the engineering and manufacturing world. (www.f1in schools.ca)

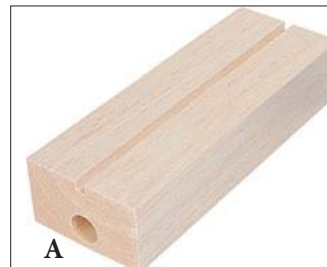

A

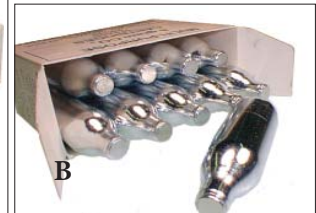

B

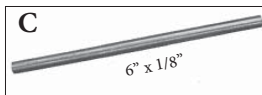

C

6" x 1/8"

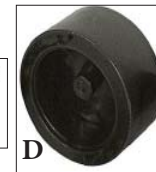

D



E



F



G

Fig	Cat #	Description	Qty 1	2-5	6-19	20-49	50+
A	19-7013	Balsa Blank 223mmx65mmx50mm (Official F1)	\$6.45	\$5.85	\$5.40	\$4.85	\$4.55
B	19-1018	8gm CO2 Cartridge	\$1.02	\$0.95	\$0.87	\$0.80	\$0.77
C	19-7027	Aluminum Axle 3mm x 152mm (cut to make 2 axles)	\$1.40	\$1.23	-	-	-
D	19-7016	F1 Fusion Black Tire	\$84	\$63	\$42	\$38	\$36
E	19-1022	Straws 10/pkg (axle bearing)	\$45	\$30	\$29	\$27	\$26
F	19-1021	Brass Washers 10/pkg	\$80	\$75	\$70	\$60	\$55
G	19-1024	Screw Eyes 1/4" 25/pkg	\$3.95	\$3.30			-
H	19-7010	Complete Car Kit	\$14.60	\$13.25	\$11.95	\$10.60	\$9.55



H

F1 Basic Car Kit

If you want to give more of your students the opportunity to design, make and test, then the F1 Basic Car Kit is what you need. Kit includes one F1 balsa wood blank, four wheels, one Co2 cartridge, axles, screw eyes, and washers.

A...Elastic Car Design Class Pack

Wind the elastic band around the axle to propel this car.

- SINGLE KITS (PACKAGED) - CAT# 80-5429-SK.....\$4.95
 - 50 STUDENT CLASS PACK - CAT# 80-5429-00.....\$146.00
- The kit includes all the pieces to build 50 cars. (Plans Included)

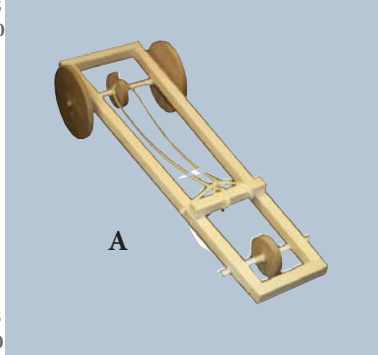

B...Hovercraft 12 Student Class Pack

The Kidder Hovercraft is a great activity that will introduce your students the concept of frictionless motion.

- 12 STUDENT CLASS PACK - CAT# 80-5470-00.....\$95.00

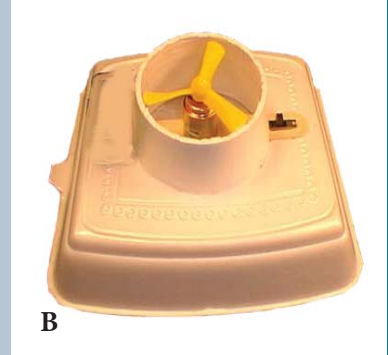

C...Air Motor Car Class Pack

The propeller attaches to the motor shaft to move the car along.

- SINGLE KITS (PACKAGED) - CAT# 80-5465-SK.....\$10.95
 - STUDENT CLASS PACK - CAT# 80-5465-00.....\$210.00
- The kit includes all the pieces to build 24 cars. (Plans Included)

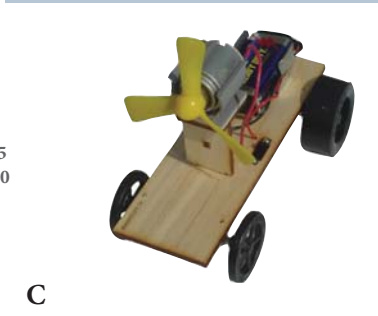

D...Worm Gear Car Class Pack

The motor attaches to a worm gear which moves the gear on the axle. (High torque design).

- SINGLE KITS (PACKAGED) - CAT# 80-5462-SK.....\$12.75
 - 24 STUDENT CLASS PACK - CAT# 80-5462-00.....\$250.00
- The kit includes all the pieces to build 24 cars. (Plans Included)

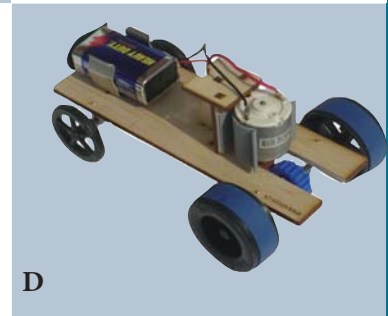

E...Solar Car Class Pack

This new solar car kit works well in bright sunlight and demonstrates the science of solar energy.

- SINGLE KITS (PACKAGED) - CAT# 80-5438-SK.....\$24.95
 - 12 STUDENT CLASS PACK - CAT# 80-5438-00.....\$280.00
- The kit includes all the pieces to build 12 cars. (Plans Included)

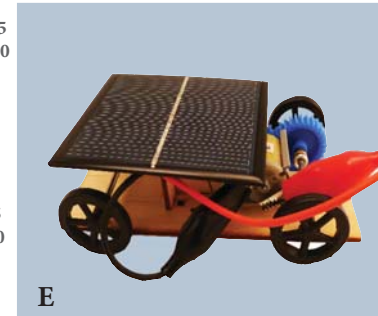

F...Electric Car Kits Class Pack (Pulley Drive)

This simple value packed kit explores movement, electricity and forces. All parts, instructions and battery are included.

- SINGLE KITS (PACKAGED) - CAT# 80-5433-SK.....\$13.25
 - 24 STUDENT CLASS PACK - CAT# 80-5433-00.....\$226.00
- The kit includes all the pieces to build 24 cars. (Plans Included)

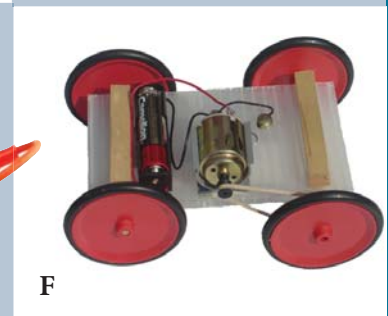

G...Motor Car Class Pack

The motor pulley uses a band around a pulley on the wheel axle to propel this car.

- SINGLE KITS (PACKAGED) - CAT# 80-5435-SK.....\$12.95
 - 30 STUDENT CLASS PACK - CAT# 80-5435-00.....\$290.00
- The kit includes all the pieces to build 30 cars. (Plans Included)

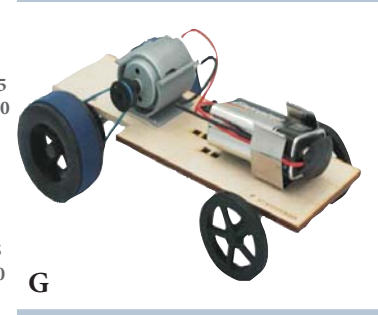

H...Propeller Car Class Pack

Wind the propeller and watch this car go.

- SINGLE KITS (PACKAGED) - CAT# 80-5431-SK.....\$3.95
 - 35 STUDENT CLASS PACK - CAT# 80-5431-00.....\$98.00
- The kit includes all the pieces to build 35 cars. (Plans Included)



I...Balloon Jet Car Class Pack

Blow up the balloon and watch it go! Students will learn the concepts of Newtons Law of Motion, friction and jet propulsion through this simple kit.

- SINGLE KITS (PACKAGED) - CAT# 80-5469-SK.....\$5.75
 - 18 STUDENT CLASS PACK - CAT# 80-5469-00.....\$88.00
- The kit includes all the pieces to build 35 cars. (Plans Included)

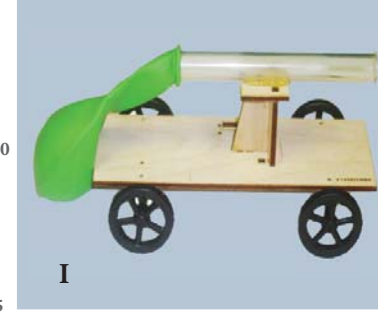

J...Card Wheel Car Class Pack

This car is an excellent project for the junior grades to test velocity on an incline track, weight distributions and wheel ratios. Cars can be coloured by students.

- 50 STUDENT CLASS PACK.....CAT# 80-5443-00.....\$44.95



Mousetrap Car Kits for Speed



What is friction and how can it be managed? How is energy measured? How is speed calculated? These questions will be answered with these racers. Use them as a "hands on" supplement to teach power and transportation.

Qty	Price
1-1	\$11.75
2-5	\$10.60
6+	\$10.10

*12 Student Class Pack
CAT# 19-20-543....\$115.00
(2+ \$103.00)

INDIVIDUAL KITS
CAT# 19-20-542



Bulk Mousetraps Cat# 19-20-541

Individual Mouse Traps
36/pkg

Qty	Price
1-1	\$30.90
2-up	\$28.10

Mousetrap Car Kits for Distance

INDIVIDUAL KITS
CAT #19-5444-SK...\$10.00

Qty	Price
2-5	\$9.25
6+	\$8.75



36 STUDENT CLASS PACK
CAT# 19-5444\$255.00

In this guide written by a Teacher-of-the-Year winner, your kids will learn how to construct race cars from ordinary, affordable household materials, while learning the science behind how they work, in language easy enough for a 7th grader to understand. With colour photos, diagrams, fun illustrations, and four complete projects, your family will be racing vehicles that go the distance! A bonus project is included for students looking for super science fair project.

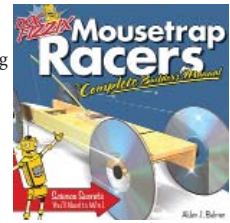

CAT# 80-5758-00 \$19.05

Design and make your own Mousetrap Cars with parts below.



Screw Eye Axle Holders

Screw eyes are used to hold axles in place. Build a wooden frame, add your axle-holders, wheels and you're ready to roll! 100/pkg.

- A) CAT# 19-54-1024 \$9.35
For 1/8" diam. dowel/axles
- B) CAT# 19-20-545 \$9.00
For 9/64" for 4mm dowel/axles
- C) CAT# 19-20-546 \$9.00
For 7/32" for 3/16" dowel/axles

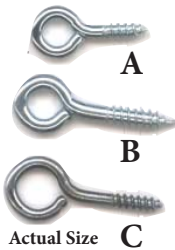

Actual Size C

Metal Eyelets



Actual Size

Use these eyelets as wheel bearings 100/pkg (Axle will run freely).

- For 1/8" axles CAT# 19-20-553 \$2.40
- For 4mm axles CAT# 19-20-552 \$3.95
- For 5mm axles CAT# 19-20-554 \$4.00

CD Hub/Wheel

These plastic CD hubs snap into place and can be used with a 4mm axle. They can also be used as wheels.
CAT# 19-20-558P 6/PKG
\$2.70



Super Wheels

Multi-purpose reusable tires made from a large red plastic pulley and rubber rings. All with 4mm diameter axle hole. 10/pkg.
CAT# 83-54-1248 (50 MM) \$8.55
CAT# 83-54-1246 (38 MM) \$7.85
CAT# 83-54-1244 (25 MM) \$6.70



Bulk Wheels

100pcs Front Wheels
1 5/16 Diam (34 mm) to fit 1/8" diam axles.
CAT# 19-54-1015\$22.50

Nylon String

This very strong nylon string is excellent for use in mousetrap racing. 36 pcs of 36" lengths.
CAT# 19-20-548 ...\$7.20



Wood Dowels x 24"

CAT# 83-2002B02.....\$3.70
4mm Wood Dowels 16" 12/pkg
CAT# 83-2003-02 \$4.90
3/16" Wood Dowels 24" 8/pkg

(See page 12 for more sizes)

Mag-Lev Cars

30 Student Class Pack

Maglev is a transport method that uses magnetic levitation to move vehicles without touching the ground. With maglev, a vehicle travels along a guideway using magnets to create both lift and propulsion, thereby reducing friction by a great extent and allowing very high speeds. Bring concepts like Polarity, Attraction, Repulsion, Magnetic Field & Current to life through this Maglev class pack! Kit includes the parts to build your magnetic levitation cars (excluding body material, batteries & wire).

30 Student Class Pack includes:

- 5 X 80-3550.....3-9V INPUT TOY MOTOR 6/PKG
- 5 X 80-3555.....3" PLASTIC PROPELLERS 6/PKG
- 3 X 80-3560.....MAGNETS 50/PKG
- 1 X 80-5747.....5/PKG PROCEDURE SHEET

CAT# 80-5450-00.....\$125.00



Mag-Lev ACCESSORIES

Mag-Lev Track



The Maglev Track includes two aluminum 4' tracks, as well as four 4' strips of magnet that act to repel your car and keep it in the air. Includes two track pieces to hold two track pieces together. Dimensions: 4' x 3 3/4" sections.

CAT # 80-5454-00.....\$435.00

9V Battery Strap



Use this 9v battery strap to connect your battery to a motor and switch to power your Maglev car. 6/pkg

CAT # 70-32-236.....\$2.40
(6+ \$2.20)

Toy Motors



High-speed motor can produce up to 17K/RPM. Ideal for Maglev. Input up to 3-9V DC, 2 mm spindles. 6/pkg

CAT# 80-3550-00.....\$8.90
(6+ \$7.55)
(see more motors on page..)

Magnets



Ideal for creating Maglev vehicles, tracks and more. Dimensions: 1" x 3/4" x .187 (25 x19 x 5 mm) 50/pkg

CAT# 80-3560-00.....\$18.90
(6+ \$16.80)

Propellers



3" (76 mm) plastic high-speed propeller with three blades. (Fits motor 80-3550-00 sold separately). Ideal propeller for model planes, mag-lev, etc. 3 blades with 2mm hole. (assorted colours) 6/pkg

CAT# 80-3555-00.....\$7.90
(6+ \$7.20)

Wooden Paddles (Bulk)



A) Wood Paddles 6" x 3/4"
CAT# 34-54-1013 \$11.00
500/PKG

B) Popsicle Sticks 4 3/8" x 3/8"
CAT# 83-1600-00..... \$4.65
1000/PKG

3/16" Basswood Sheets



Use these 4"x24"x3/16" basswood sheets as chassis for your Maglev Car. 6/pkg

CAT # 83-BW406.....\$26.90

Corrugated Plastic



Use these sheets as an option for your Maglev Car Chassis. Easy to cut! This package comes with 7 sheets with a variety of colours. Sheets are 24"x32"x4mm. 7/pkg

CAT # 80-54-1200.....\$30.00

50 ft Magnetic Strip

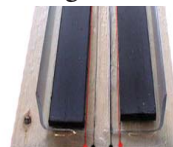

Flexible Magnetic High Energy Strip with adhesive. Thickness x Width: 0.125" x 50 ft. Ideal for a Mag-Lev track!

CAT # 80-3560FLX.....\$98.00

Multi Core Stranded Wire



100m reel of multi-core. 22 gauge wire available in either black or red. Used to connect your switches, batteries and motors.

I CAT# 80-3505-00 RED.....\$19.30
II CAT# 80-3506-00 BLACK.....\$19.30

Toll Free 1.800.263.3556 • Toll Free Fax 1.800.731.8424 • www.kidder.ca

Prices are subject to change without notice

Wheels

A...Thick Card Wheels

Thick card disks with 3/16" hole. 100/pkg. (See page 16 for project ideas)

CAT# 83-1214-00	25MM.....	QTY 1 \$5.95, 2-5 \$4.45	100/PKG
CAT# 83-1216-00	38MM.....	QTY 1 \$9.05, 2-5 \$7.90	100/PKG
CAT# 83-1218-00	51MM.....	QTY 1 \$12.10, 2-5 \$9.10	100/PKG
CAT# 83-1219-00	63MM.....	QTY 1 \$15.05, 2-5 \$11.30	100/PKG
CAT# 83-54-1200	(200 ASSORTED)		\$24.95 200/PKG



B...MDF Wheels

These 6mm thick fibre board wheels come with drilled centre holes for 4mm or 3/16" dowel. Diameters of 34mm, 54mm, and 74mm (100/pkg) or a mixed bag of 150/pkg. (See also pg. 11)

4MM DIAMETER HOLE

CAT# 83-1247-00	34MM.....	\$22.50	100/PKG
CAT# 83-1249-00	54MM	\$27.00	100/PKG
CAT# 83-1251-00	74MM	\$32.50	100/PKG
CAT# 83-54-1253	ASSORT.150/PKG	\$39.95	100/PKG



3/16" DIAMETER HOLE

CAT# 83-1256-00	34MM	\$22.50	100/PKG
CAT# 83-1258-00	54MM	\$27.00	100/PKG
CAT# 83-1260-00	74MM	\$32.50	100/PKG
CAT# 83-54-1262	ASSORT.150/PKG	\$39.95	100/PKG

C...Plastic Spools

Pack of 50 plastic spools in assorted colours for wheels. Use small card disks to secure axles through spools. Axle hole 5/16" diam. Can be used as wheels or pulleys.

CAT# 83-1240-00.....\$49.90 100/PKG



D...Super Wheels 4mm axle hole

Multi-purpose, reusable tires made from a large red plastic, pulleys, and rubber rings. 4mm axle hole 10/pkg

CAT# 83-54-1248	50MM	\$8.55	10/PKG
CAT# 83-54-1246	38MM	\$7.85	10/PKG
CAT# 83-54-1244	25MM.....	\$6.70	10/PKG



E...Bulk Front Wheels

These plastic wheels are 33mm x 5mm. They use a 3mm (1/8") axle. CAT# 19-5425\$99.50 500/PKG

F...Bulk Rear Wheels

These rear wheels are 40mm x 16mm. They use a 3mm (1/8") axle. CAT# 19-5426\$146.50 500/PKG

G...Screw Eye Axle Holders

Screw eyes are used to hold axles in place. Build a wooden frame, add your axle-holders, wheels and you're ready to roll! 100/pkg

I) CAT# 19-20-546.....	\$9.00	100/PKG
7/32" for 3/16" dowel/axles		
II) CAT#19-20-545.....	\$9.00	100/PKG
9/64" for 4mm dowel/axles		
III) CAT# 19-54-1024	\$9.35	100/PKG
1/8" diam. dowel/axles		

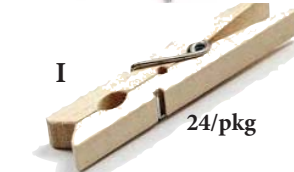

H...Axle Gussets (with 3/16" hole)

These cardboard supports can be used to hold axles in place. 500/pkg CAT# 19-20-557 55X39X39MM 5MM HOLE\$18.75 500/PKG

I...Clothespins 24/pkg

These can be used to hold joints while adhesive dries or as axle supports. CAT# 83-2015-00.....\$3.55 24/PKG

J...Mini O'ring Washers

Washers are used to keep the wheels in place on axles. Fit on 3/16" or 4 mm axles. CAT# 19-20-555\$5.00 100/PKG

K...CD Hub/Wheels

These plastic CD hubs snap into place and can be used with a 4mm axle. They can also be used as wheels. CAT# 19-20-558P.....\$2.70 6/PKG

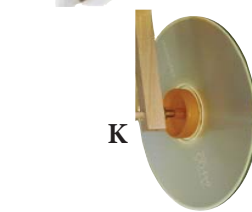

Traction Bands

These wide bands work perfectly with the rear dragster slicks (19-1016) to provide more traction with running races. 100/pkg



CAT# 19-2012-00.....\$4.10

Wheels ENGbox

This box contains over 400 pcs of plastic, mdf, and card wheels as well as axles and dowel and screw eyes. It comes in a handy parts organizer. CAT# 8354ENGBXW.....\$110.00



Thick Card Wheels

A very stiff card wheel with a centre drilled with a 3/16" hole which is a good tight fit on 3/16" dowel. They are available in 25mm, 38mm 51mm and 63 mm or in a mixed bag. A project idea sheet is included. More ideas can be found in the book Design and Make Mechanisms 1 (Cat# 8057)JINK06 or Rainbow Technology (Cat# 80-5739-00). The wheels are sold 100/pkg.



3/16" Hole
100/pkg

Cat#	Size	Qty 1	2-5	6+
83-1214-00	25mm	\$5.95	\$4.45	\$4.10
83-1216-00	38mm	\$9.05	\$7.90	\$6.20
83-1218-00	51mm	\$14.10	\$10.60	\$9.70
83-1219-00	63mm	15.75	11.80	10.85
83-54-1200	Mixed Bag 200/pkg	\$24.95	-	-

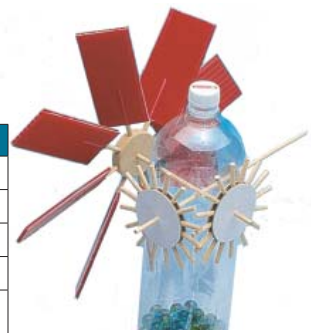

Wooden Cams



Add simple mechanisms to any model with these ready made wooden cams. Single rise, double rise and snail cams offer you the chance to add movement to your own 'design and make' model. Cams fit 3/16" dowel and have a maximum diameter of 73mm.

CAT# 80-3572-50.....\$26.45

Off-Centred Mass Wheel



Fits directly onto a 2mm motor spindle and provides the imbalance needed for 'bugs' and vibrating mechanisms.

CAT# 80-3572038.....\$3.40 6/PKG

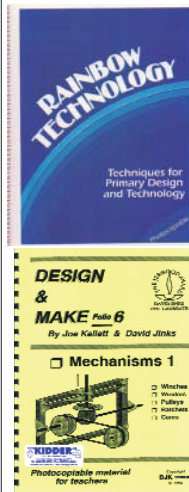

Rainbow Technology

This book provides 104 photocopiable sheets in 12 sections, accompanied by teacher's notes and technological challenges. Subjects covered are electricity, structures, motor, pneumatics, photography, fastening, construction and much more.

CAT# 80-5739-00.....\$35.95
Design & Make Folio 6

This book contains a wealth of information for the elementary classroom focusing on the "Jinks construction systems" pioneered by David Jinks. These are the definitive books to help all teachers in the field.

CAT# 8057JINK06.....\$15.95

MDF Wheels

These 6mm thick fibre board wheels come with drilled centre holes for 4mm or 3/16" dowel. Diameters of 34mm, 54mm, and 74mm (100/pkg) or a mixed bag of 150/pkg.



Sold in packages of 100 or a mixed bag of 150.

See 4mm & 3/16" dowel on page 8.

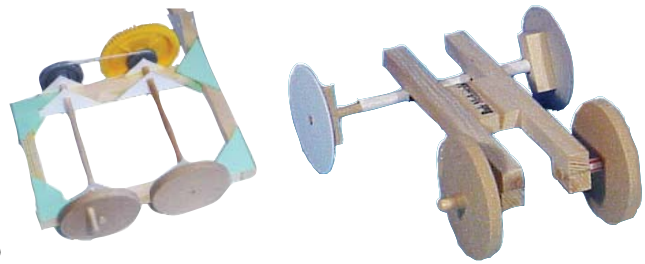

Cat#	Size	1	2-5	6-up
Cat# 83-1247-00	34mm w/4mm hole	\$22.50	\$20.00	\$18.50
Cat# 83-1249-00	54mm w/4mm hole	\$27.00	\$24.95	\$21.60
Cat# 83-1251-00	74mm w/4mm hole	\$32.50	\$30.00	\$24.00
Cat# 83-54-1253	Assorted 150/pkg	\$39.95	-	-
Cat#	Size	1	2-5	6-up
Cat# 83-1256-00	34mm w/3/16" hole	\$22.50	\$20.00	\$18.50
Cat# 83-1258-00	54mm w/3/16" hole	\$27.00	\$24.95	\$21.60
Cat# 83-1260-00	74mm w/3/16" hole	\$32.50	\$30.00	\$24.00
Cat# 83-54-1262	Assorted 150/pkg	\$39.95	-	-

Toll Free 1.800.263.3556 • Toll Free Fax 1.800.731.8424 • www.kidder.ca

Prices are subject to change without notice

Axles

Wood Skewers



These 2.5mm wood sticks can be used as axles in many projects. They are 12" long.

CAT# 83-2001-00 - 100/PKG

Qty	\$/pkg
1	\$2.30
2-5	\$2.00
6+	\$1.85

12" Steel Axles



These 12" steel rods can be cut to any length. They are 1/8" in diameter.

CAT# 19-1028 - 6/PKG

Qty	\$/pkg
1	\$4.20
2+	\$3.80
6+	\$3.15

2.5" Steel Axles



These axles are 63mm x 3mm (2.5" x 1/8")

CAT# 19-1023 2/PKG50¢
CAT# 19-54-1023 100/PKG.....\$11.00

2.5" Aluminum Axle



Aluminum Axle 3mm x 152mm (cut to make 2 axles)
CAT# 19-7023 EA33¢ (20+ 26¢)

Dowels



If you drill a 3/8" hole, a 3/8" dowel will squeak into it and not fall through it. This one goes for all sizes. You can always make a tight dowel loose. It's hard to go the other way.

Cat #	Diameter	Pkg	1	2-5	6-19	20-49	50+
83-2002-02	1/8" (3 mm) x 24"	8	\$4.40	\$4.15	\$3.85	\$3.60	\$3.30
83-2002B02	5/32" (4mm) x 16"	12	\$3.70	\$3.50	\$3.25	\$3.00	\$2.80
83-2003-02	3/16" (5 mm) x 24"	8	\$4.90	\$4.60	\$4.30	\$4.00	\$3.70
83-2004-02	1/4" (6 mm) x 24"	8	\$5.00	\$4.65	\$4.45	\$4.20	-
83-2005-02	5/16" (8 mm) x 24"	8	\$6.30	\$5.85	\$5.55	-	-
83-2006-02	3/8" (10 mm) x 24"	4	\$4.80	\$4.30	\$4.00	\$3.70	\$3.40
83-2008-02	1/2" (13 mm) x 24"	4	\$5.95	\$5.45	\$5.00	\$4.50	\$4.00
83-2009-02	5/8" (16 mm) x 24"	2	\$4.10	\$3.70	\$3.30	-	-
83-2010-02	3/4" (19 mm) x 24"	2	\$3.85	\$3.50	\$3.15	-	-
83-2011-02	1" (25 mm) x 24"	2	\$5.85	\$5.45	\$5.15	\$4.90	\$4.60
83-2013-02	1 1/4" (25 mm) x 24"	2	\$11.20	\$10.45	-	-	-



Kidder supplies genuine Scalextric components available at a discount to schools.



B



C



E



F



G

H



A.... Basic Car Kits

Each pack contains enough components to build 30 standard cars. Add some acrylic, HIPS and flexible wire and you have everything you need to build and race your cars.

CAT# SCLX548523 30 Kit School Pack....\$203.00
CAT# SCLX-C8523 Single Kit Qty 1 - \$9.55
(2-5 \$8.35, 6+ \$7.65, 20+ \$7.15)

B.... Track

The track almost fills a table tennis table and comes with power pack and two hand controllers. It will allow you to test and practice in preparation for the race element of the competition.

CAT# SCLX-C8524 Track Pack\$113.50

C.... Laser Pre-Cut Chassis Component

For those who do not have a CNC milling machine or software to operate it, may we suggest you purchase the chassis components pre-cut from 1/8" acrylic plastic.

CAT# SCLX-C85CH\$10.00 EA
(2+ \$9.00)

D.... Assembly Guide

This guide can be downloaded from the SCALEXTRIC4SCHOOLS.ORG or by request.

CAT# SCLX-C85AG\$3.75

E Competition Rule Guide

This guide has all the information you need to run competitions within your school or board wide.

CAT# SCLX-C85CR.....\$2.95

F Edge Scraper

This scraper is used to take the rough edges off the plastic. (Check out our plastic sheets page 33)

CAT# 80-3206-00\$16.90
(2+ \$15.00)

G.... Earth Magnets

Use these powerful Earth Magnets (2 per car) to stabilize the cars on the track by the magnetic pull (as seen in the subsequent picture on the chassis).

CAT# 80-35MAG38 10/pkg\$8.20

H ... Primary Vacuum Former (See page 55)

Manufacture the Scalextric Car bodies using Kidder's TechSoft Primary Vacuum Former.
CAT# 75-PRIMARY.....\$1659.00
(See sheets on page 55)

PineCar^R Racer Basic Car Kit

Qty	Price
1	\$9.25
2-5	\$8.20
6-19	\$7.80
20+	\$7.60



CAT# 19-8010-00

Kit includes wood block, wheels, hubcaps, two lead-free one-piece axles and four lead-free nail-type axles. Wheels and axles should be the same on all cars in a race.
Block dimensions - 4.44 cm x 17.7 cm 1(3/4" w x 7" 1)

Program Guide For Pine Car



A 19-page, fully-illustrated race sponsor's guide with easy step-by-step instructions on conducting a PineCar Derby or SailBoat Raingutter Regatta. It includes information on how to plan the event, how to set up the race floor plan, how to select the car and sailboat kits for the derby, how to build a raingutter course and how to organize the race to benefit everyone! Don't forget the ribbons, trophies and certificates!

CAT# 80-5794-00.....\$6.55

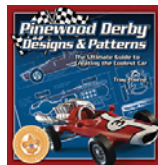

Cat# 80-5793-00
\$19.45 ea



Cat# 80-5792-00
\$19.45 ea

See pg. 47 for more book details

PineCar^R Block

Qty	Price
1	\$4.65
2-5	\$4.20
6-19	\$3.70

The fine-grain, soft wood is lightweight and easy to cut and the Block comes with pre-drilled axle slots. Just shape, sand, paint and decorate. Includes step-by-step, illustrated instructions.
Block dimensions - 1 3/4" w x 7" 1 (4.44 cm x 17.7 cm)
CAT# 19-8013-00
OR BUY BULK
25/pkg
CAT#19-54-8013 \$92.00

Pine Car Axles

Five high-quality, lead-free, nail-type axles. Use to replace damaged or lost axles. They meet BSA specifications.



CAT# 19-8023-00..\$1.13 5/PKG

OR

Buy Axles in BULK 100/pkg (as illustrated above)
CAT# 19-54-8023.....\$12.00

A-D..Dragster Decals

Dry Transfer Decals are the fastest and easiest way to customize a derby racer. Colourful stripes, flames, numbers, and graphics apply easily in seconds. They are high-quality rub-on decals that can be applied around contours and over textures. With Dry Transfer Decals there is no clear film around the edges of decals. (Size 102 x 127mm)

- CAT# 19-P318 Custom\$10.40
- CAT# 19-P307 Stripes & Flames.....\$10.50
- CAT# 19-P317 Nascar\$10.50
- CAT# 19-P314 Hot Rod\$10.50

PineCar^R Wheels & Axles Kit



Includes four replacement wheels, two lead-free, one-piece axles, four lead-free, nail-type axles and five hubcaps.

CAT# 19-8015-00.....\$1.98

OR BUY BULK

Wheels ONLY 100/pkg (as illustrated above)
CAT# 19-54-8015.....\$23.00

- A) Custom Cat# 19-P318
- B) Stripes & Flames Cat# 19-P307



- C) Nascar Cat# 19-P317
- D) Hot Rod Cat# 19-P314

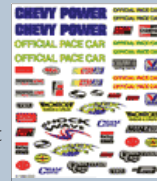

Tracked Vehicle Chassis Kit

The Tracked Vehicle Chassis traverses over objects in its path and rough terrain. Use this kit as a stand-alone or combine it with other accessories making a more complex machine with more capabilities. The gear box can be built with two possible gear ratios—Standard: 203.7:1 or High Speed—58.2:1.
Motor: FA-130
Gear Box: Two gear ratio possibilities, standard and high



CAT# 9799-70108.....\$23.95



Remote Controller Kit 2

This set includes all basic parts needed to build a crawler-type remote control robot. This allows users not to worry about gathering parts, and instead concentrate on building the robot, making it perfect for using in fair and balanced classroom projects. This kit includes a 4-channel remote control box, twin-motor gearbox, tracks and roller wheels, universal arms, plate and rivets.

CAT# 9799-70170.....\$61.50

Toll Free 1.800.263.3556 • Toll Free Fax 1.800.731.8424 • www.kidder.ca

Prices are subject to change without notice

Assorted Plastic Pulleys

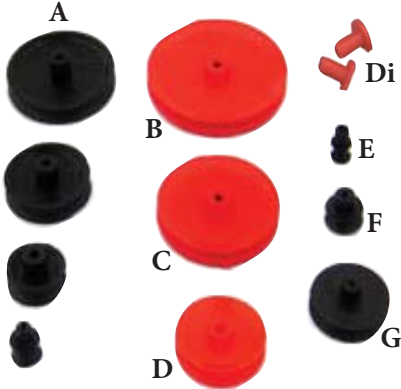

Fig A..... Pulleys *See kidder.ca for bulk pricing
 4 sizes of pulleys (10 each size) 10, 20, 30, 40 mm. 10 mm fits toy motors, 2 mm shaft can be bored out to 3 mm (1/8").
CAT# 80-3580-00 PKG \$14.00

Fig B - D Red Pulleys
 C, D, E...Red pulleys in three sizes 25, 28, and 50 mm diam. Centre hole is 4 mm. Pack 10.
B. CAT# 80-3591-00 50 MM 10/PKG.....\$5.40
C. CAT# 80-3592-00 38 MM 10/PKG.....\$4.90
D. CAT# 80-3593-00 25 MM 10/PKG.....\$4.50

Di. Bushings for Red Pulleys.
CAT # 80-3588-00 20/PKG.....\$2.00

Fig E - G. Motor Pulleys
 These motor pulleys fit directly on the motor shaft (2 mm). They are available in three sizes and are sold in packs of 10 (see motor page 13).
E. CAT# 80-3577-00 10 MM 10/PKG.....\$3.95
F. CAT# 80-3577-50 12 MM 10/PKG.....\$6.95
G. CAT# 80-3577-75 25 MM 10/PKG.....\$9.75

Pulley Cars - see pg 7



Mixed Pulley Pack



60 Pulley Pack Assorted

This mixed pulley pack has 20 of each size red pulley 25, 38 and 50mm.

Cat#	Description	1	2-5	6-19	20-49	50+
80-54-3594	Mixed Pulley Pack of 60	\$25.00	\$22.50	\$21.25	\$20.00	\$18.75

Rubber Bands

(*Used as pulley drive belts)



#14 Rubber Bands
CAT# 19-2016-00 1 LB ...\$10.00
CAT# 19-2016-25 1/4 LBS \$2.75

#16 Rubber Bands
CAT# 19-2019-00 1 LB\$9.75
CAT# 19-2019-25 1/4 LBS \$2.75

#18 Rubber Band
CAT# 19-2022-00 1 LB\$9.75
CAT# 19-2022-25 1/4 LBS \$3.00

#19 Rubber Band
CAT# 19-2023-00 1 LB ...\$11.25
CAT# 19-2023-25 1/4 LBS \$3.10

O-Rings

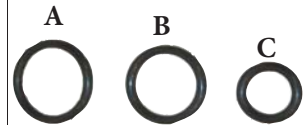

Use these rings to convert your plastic pulleys into wheels. 10/pkg.

Fig A...50 mm
CAT# 83-1248-00 \$3.20

Fig B...38 mm
CAT# 83-1246-00 \$2.95

Fig C...25 mm
CAT# 83-1244-00 \$2.75

Pulley Blocks

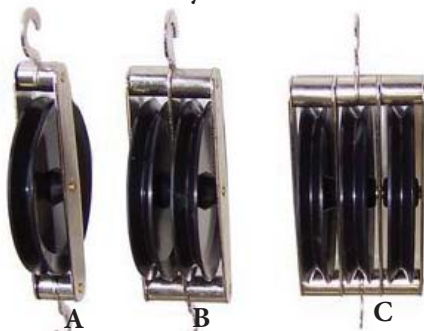

Pulley blocks are free running 50 mm diam pulleys in a house with swivel hooks at each end.

Fig A...Single
CAT# 80-3594-01\$2.50

Fig B...Double
CAT# 80-3594-02\$3.60

Fig C...Triple
CAT# 80-3594-03\$5.35

The set of 5 pulleys blocks contains 2 single, 2 double, and 1 triple blocks.
CAT# 80-543594X\$14.95

Pulleys & Gears ENGbox



This convenient tote is filled with an assortment of pulleys, gears, motor pulleys, worm gears, and dowels.

CAT# 8354ENGBXP.....\$145.00

Pulley Cord



Nylon cord that runs well in the pulley blocks. 20m roll.
CAT# 19-20-547.....\$9.30

Bushings



Bushings convert a 4 mm hole into a 2mm hole that fits a motor.

20/pkg.
CAT# 80-3588-00.....\$2.00

Check out the Wood Dowels on Page 12

Gears for All Your Needs

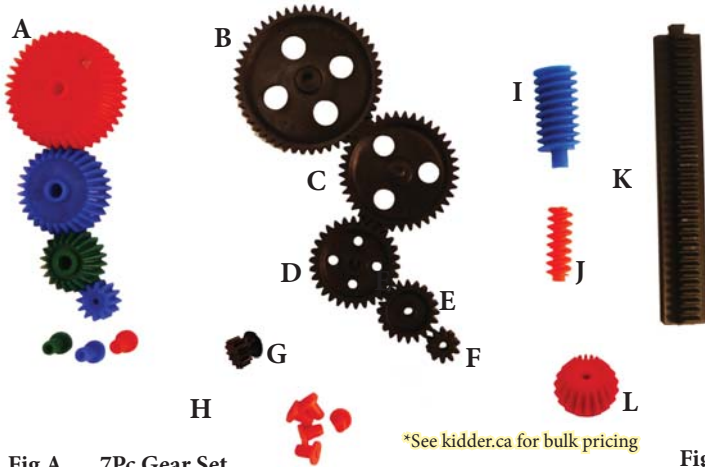

Fig A.....7Pc Gear Set

This set of gears contains 40, 30, 20, and 12 tooth gears with 3/16" hole diameters and 3 bushings. There are 4 sprues per package. 2 mm motor spindle 12 tooth gear included. Assorted Colours.

CAT# 80-3570-00..... \$4.85 4 SETS/PKG

Fig B-FPlastic Gears

These red plastic gears fit tightly on 4 mm dowel. Each pack of 10 gears comes with bushings to make a hole 2 mm to fit a motors shaft. They are sold 10/pkg.

- B. CAT# 80-3569-50 50 TEETH.....\$6.60
- C. CAT# 80-3569-40 40 TEETH.....\$5.85
- D. CAT# 80-3569-30 30 TEETH.....\$5.00
- E. CAT# 80-3569-20 20 TEETH.....\$4.35
- F. CAT# 80-3569-10 10 TEETH.....\$3.45

Fig G.....Motor Pulley/Gear

This motor spindle gear fits our standard 2 mm motor shaft. It has 10 teeth and can also be used as a pulley. They are sold 20/pkg (see page 17).

CAT# 80-3574-00.....\$8.05



*See kiddr.ca for bulk pricing

BULK Mixed Gears Packages



50T, 40T, 30T, 20T, 10T w/ 4mm Hole

Cat#	Description	1	2-5	6-19	20-49	50+
80-54-3568	5/pkg - 1 of each size (B to F) + 5 bushings	\$5.00	\$4.50	\$4.05	\$3.65	\$3.15
80-54-3569	50/pkg - 10 of each size (B to F) + 20 bushgs	\$24.00	\$21.60	\$20.40	\$19.20	-

Fig HBushings

These bushings convert a 4 mm hole to a 2 mm hole for a push fit onto a motor. They are sold 20/pkg.

CAT# 80-3588-00.....\$2.00

Fig I-JWorm Gears

These worm gears mesh with the 10, 20, 30, 40 and 50 tooth gears. They are available in small and large. The large gears fit end to end and also fit a 2 mm motor shaft.

- I. CAT# 80-3575-LG 10/PKG LARGE.....\$10.75
- J. CAT# 80-3575-SM 10/PKG SMALL.....\$9.00
- CAT# 80-54-3575 10 SM/10 LG...SPECIAL PRICE.....\$17.70

Fig K.....Gear Racks

These gear racks are in two sizes and mesh with gears. The small rack can be fastened to a base. The large rack is interlocking.

K. CAT# 80-3574-25 100 MM 10/PKG.....\$13.65

Fig LBeveled Gears

45 degree Bevel 27mmX6mm

CAT# 80-3571-30 10/PKG.....\$20.00

Gear Set



This set of gears is designed for use on model projects. The small 8 tooth gear will fit on most 2mm motor shafts that are found on lots of DC motors. Gears have a keying feature that allows them to be changed quickly and easily from the key. Once the key is secured to the driveshaft the gears can be removed quickly without glue or tape etc. The key will press fit on 7/64" diameter. It can also be drilled out to fit larger shafts.

CAT# 80-3KW065 \$17.80 /PKG

- (4) Gears (teeth = 64, 32, 16, 8)
- (1) Driveshaft Key

Make Your Own Gear



This jig design allows you to design different combinations of gears on each side. On one side, the combination is 4-, 8- or 16-teeth gears. On the other side, the combination is 6-, 12- or 24-teeth gears. This jig is ideal for students of all ages to design and build windmills, cars, machines, toys, etc. out of cardboard wheels, paper and glue.

CAT# 83-3022-00\$4.60 EA

Simple Gearbox Motor

This simple gearbox and motor has a 4mm diameter output shaft which runs 40 times slower than the motor itself. Use it to drive models slowly.

(3-6v required)



CAT# 80-3538-00.....\$11.00

Twin Motor Gear Box

The Twin Motor Gear Box uses a two motor system to provide power and speed to turn the hex shaft. The gear box is made from high quality plastic. Use this gear box and motor set with other Tamiya Construction and Robotics products. Two FA-130 motors are included. Gear Ratios: 58:1 207:1 Motor: (2) FA-130

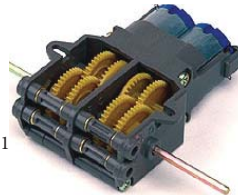

CAT# 9799-70097.....\$14.05

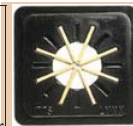

Create 8 / 16 Teeth gear sizes from cardboard or paper discs and dowels.

CAT# 83-3026-00.....\$9.85

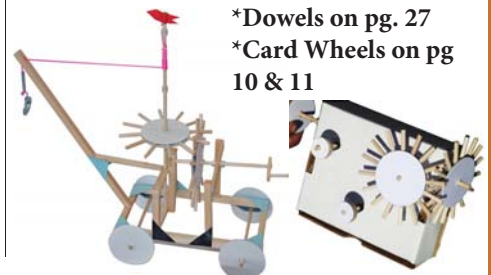

*Dowels on pg. 27
*Card Wheels on pg 10 & 11

Toll Free 1.800.263.3556 • Toll Free Fax 1.800.731.8424 • www.kiddr.ca

Prices are subject to change without notice



A..... Multi Core Stranded Wire (22 Gauge)
100m reel of multi-core wire available in either black or red.
i CAT# 80-3505-00 Red Wire..... \$19.30
ii CAT# 80-3506-00 Black Wire..... \$19.30

**See kidderc.ca for bulk pricing*



B..... Alligator Leads
Ready-made leads approximately 35 cm long, 10/pkg. Red and Black - 5 of each.
CAT# 80-3504-RB..... \$5.95

C..... Round MES Screw type Bulbs
MES refers to the size of the base thread. Sold 25/pkg
CAT# 80-3517-00 1.5V \$11.25
CAT# 80-3518-00 2.5V \$11.25
CAT# 80-3519-00 3.5V \$11.25
CAT# 80-3520-00 6V \$11.25

D..... Lens MES Bulb
This style is less likely to break if dropped. 2.5V. Sold 25/pkg
CAT# 80-3521-00 \$11.25

E..... MES Bulb lamp Socket Holder
A screwdriver is required to make connections to this holder. 10/pkg
CAT# 80-3527-00 \$8.95

F..... Simple Bulb Holder
An inexpensive socket for miniature ling bulbs. The socket has two terminals that can be attached with lead wires to batteries. Sold 10/pkg
CAT# 80-3524-00 \$3.25

G..... Switch w/Fahnstock Clips
These switches are mounted to a plastic disc. Each
CAT# 80-3540-50 \$1.63

H..... Bulb Holder w/Fahnstock Clips
Sold Each
CAT# 80-3526-00 \$1.63

I..... Break Switch
This switch breaks a circuit that is on. Sold 5/pkg
CAT# 80-3532-00 \$8.50

J..... Push Switch
Circuit switched off as soon as the switch is released. It works the same as a push door bell. 5/pkg
CAT# 80-3532-50 \$8.50

K..... Buzzers
Mini buzzers with leads. 4/pkg
CAT# 80-3534-00 1.5V \$11.25
CAT# 80-3536-00 4.5V \$11.25

L..... Slide Switch
This sub-mini switch is sold 6/pkg. SPDT .03A at 125 VAC
CAT# 80-3530-00 \$7.00

M..... Simple Slide Switch
This 35mm long switch can be used to reverse a meagre motor. 10/pkg
CAT# 80-3529-00 \$11.75

N..... Micro Switch
This useful switch can be wired either to switch on a circuit or to break a circuit.
CAT# 80-3547-00 \$3.75

O..... Toggle Switch
This switch is designed to fit through a 12mm hole in a panel if needed but may be used unmounted in simple circuits. 5/pkg
CAT# 80-3548-00 \$9.05

P..... Reed Switch
These require a magnet in close proximity to close the switch and complete the circuit. This type of switch is often used on doors for burglar alarms. 10/pkg
CAT# 80-3528-00 \$15.25

Q..... Solid Core Wire 22g
100 ft solid core spool in either black or red.
I. CAT# 80-3505-SC RED..... \$19.45
II. CAT# 80-3506-SC BLACK..... \$19.45

R..... Knife Switch
These switches are mounted on Bakelite base with screw holes. ea
I. CAT# 80-3542-00 SPDT \$4.05
II. CAT# 80-3544-00 DPDT \$4.95
III. CAT# 80-3543-00 DPST \$4.95
IV. CAT# 80-3541-00 SPST \$3.15

S..... LEDs
LEDs are an alternative to bulbs and are useful for adding colour to models. The LED require a 3V power supply. 25/pkg (5x R,G,B,Y,W)
CAT# 80-3514-00 \$6.25
(Colours can be ordered individually) Also see pg 17 for 100 pack assorted.

T..... Copper Foil
A fun and easy way to make basic circuits. This self-adhesive foil is 13mm x 33m roll.
CAT# 80-3501-00 \$25.70

U..... Copper Wire
This magnet copper wire can be used to make a DC motor. 22 gauge 150' roll
CAT# 80-3510-35 \$15.40

V..... Resistors
This 330ohm can act to reduce current flow, and, at the same time, act to lower voltage levels within circuits.
CAT# 80-3509-25.....\$1.20

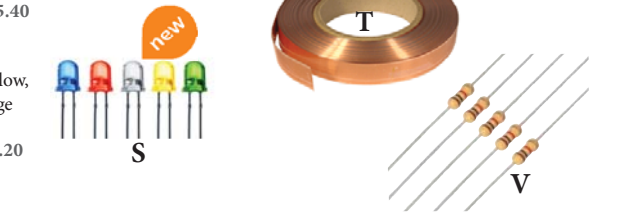
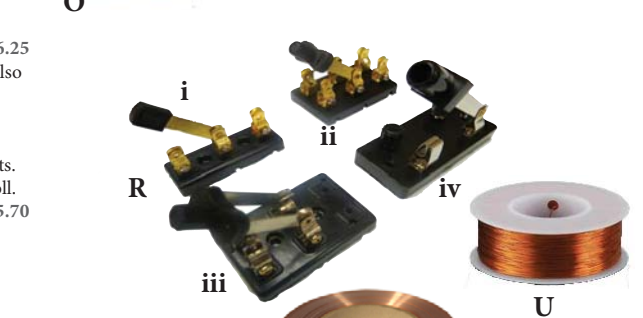
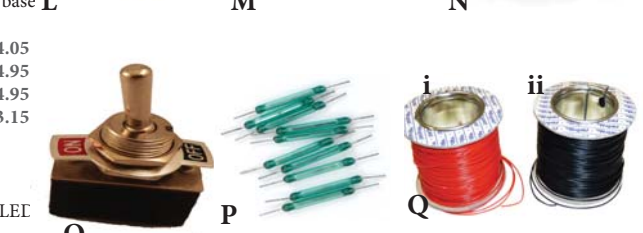
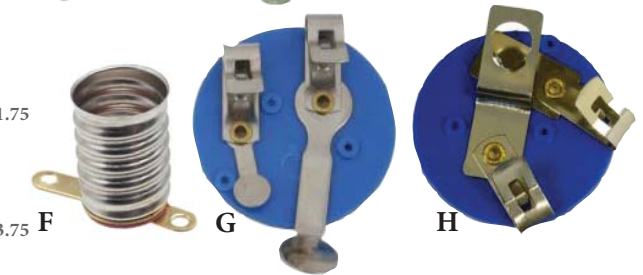
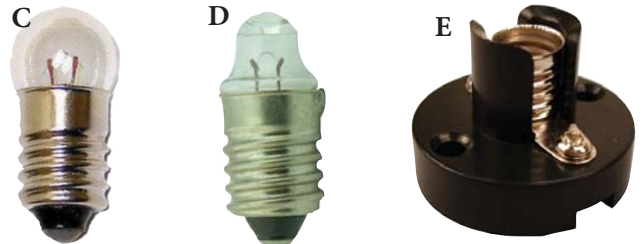

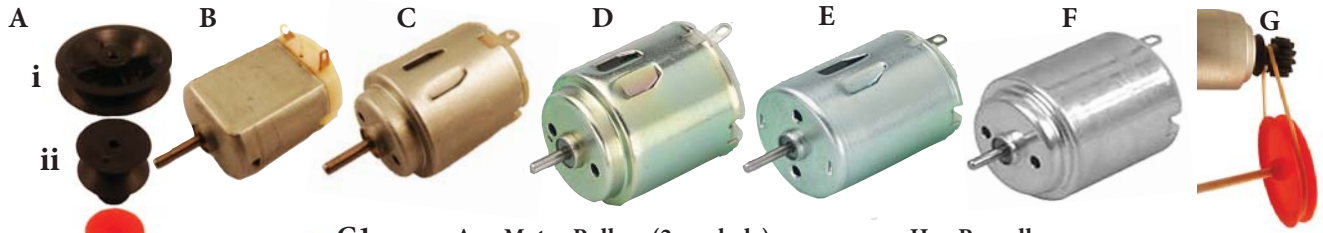

A.... Motor Pulleys (2mm hole)
 These pulleys fit directly on the motor shaft. They are available in 3 sizes and are sold 10/pkg
 I. CAT# 80-3577-75 25MM.....\$9.75
 II. CAT# 80-3577-50 12MM.....\$6.95
 III. CAT# 80-3577-00 10MM.....\$3.95

B.... Motor 1.5V-3V
 This motor is ideal for solar projects. 2mm spindle. Sold 6/pkg
 CAT# 80-3545-SO.....\$8.30

C.... Motor 1.5V-4.5V
 This motor will work with a one or two batteries. 2mm spindle. Sold 6/pkg
 CAT# 80-3545-00.....\$8.75

D.... Motor 1.5V-7V
 This motor will take a higher voltage. 2mm spindle. Sold 6/pkg. 9v battery will work
 CAT# 80-3550-00.....\$8.90

E.... Motor 3V-9V
 Uses 2 or 4 batteries for greater torque. 2mm spindle. 6/pkg
 CAT# 80-3559-00.....\$10.95

F.... Motor 6V-12V
 This heavy duty motor has a 2mm spindle. Suitable for large robotic projects. Each.
 CAT# 80-3550-80....QTY 1 \$4.50 2-5 \$4.15 20+ \$2.80

G.... Motor Spindle Gear
 This spindle gear fits our motors with a 2mm shaft. It has ten teeth and can also be used as a pulley. 20/pkg
 CAT# 80-3574-00.....\$8.05

G1.. Bushings
 These convert a 4mm hole to a 2mm hole for a push fit onto a motor. 20/pkg
 CAT# 80-3588-00.....\$2.00

H ... Propellers
 3" (76mm) plastic high-speed propellers with three blades. This is an ideal propeller for mag-lev projects and fits onto a 2mm spindle. 6/pkg (motor sold sep.)
 CAT# 80-3555-00.....\$7.90

I.... Airplane Propellers
 This propeller is 150mm long. The centre fits onto a 2mm spindle. 10/pkg
 CAT# 80-3556-00.....\$14.05

J.... Solar Propellers
 This 4 blade propeller is ideal for use with solar motor 80-3545-SO. 6/pkg 2mm hole
 CAT# 80-3554-00.....\$12.00

K.... Self-Adhesive Mounts
 These self-adhesive plastic mounts can be used to secure motors, syringes, and 'C' batteries. 6/pkg
 CAT# 70-32-043 3/8".....\$6.25 (for 5cc syringe & "AA" Batteries)
 CAT# 70-32-063 5/8".....\$5.60 (For 10cc & up syringe & "C" Cell Batteries)

L ... Gears
 Refer to page 15 for information.

M... Aluminum Clips
 These clips hold motors, syringes, and batteries. 6/pkg
 CAT# 70-32-093.....\$3.90

N.... Alligator Clips
 Alligator clips with insulation and screw terminals.
 CAT# 80-3508-00 10/PKG.....\$3.80 (2+ \$3.60)

O.... Capacitor
 A 4700 uF 6.3 Volt capacitor. A capacitor is a circuit component that is made of two conducting surfaces (plates) separated by a dielectric (non-conducting insulator) material. Sold Individually.
 CAT# 80-3500-13.....\$2.25 EA



L Gears (see page 15)

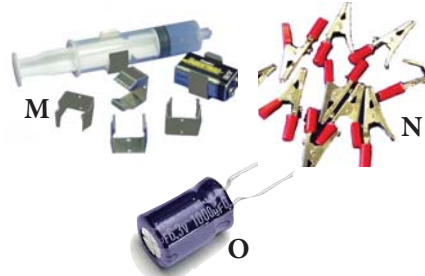

Off-Centred Mass Wheel



Fits directly onto a 2mm motor spindle and provides the imbalance needed for 'bugs' and vibrating mechanisms. Motor not included

CAT# 80-3572038.....\$3.40 6/PKG

Parts Organizer with Dividers



This parts organizer bin is ideal to keep all your buzzers, bulbs, switches, gears, pulleys etc. organized. 420mm x 305mm x 61mm (16.5" x 12" x 2.4")

CAT# 83-1189-00.....\$20.15

LED Assorted Pack



Features:

- 18 Varieties 100 Pieces
- Contains: Small, Standard, Large, Rectangular, Bi-Color, Blinking and Ultra Bright.
- Contains: Red, Amber, Green, Blue, Yellow and White.
- Packaged in a cardboard organizer box

CAT# 80-3514PAK.....\$28.85

Toll Free 1.800.263.3556 • Toll Free Fax 1.800.731.8424 • www.kidder.ca

Prices are subject to change without notice



A...Wire
(Multi core Stranded)
100m Roll
RED.....CAT# 80-3505-00 \$19.30
BLACK.....CAT# 80-3506-00 \$19.30



B...Wire Stripper
This useful tool strips away the plastic insulation. leaving wire strands exposed.
CAT# 83-1138-00.....\$9.95

C...30 W Soldering Iron (w/ stand)
CAT# 80-4855-00 30W.....\$12.25



D....Soldering Gun
This pistol grip soldering gun is 100watts. 40gm solder tube.
CAT# 80-4859-00.....\$31.05
Di..CAT# 80-4856-00 40gm Solder \$3.40

EScrewdriver/Wirestripper
A slothead screwdriver that is used for small screws like those on the chrome switch or battery bulb holder. It has a wire stripper in the handle.
CAT# 83-1137-00\$3.00

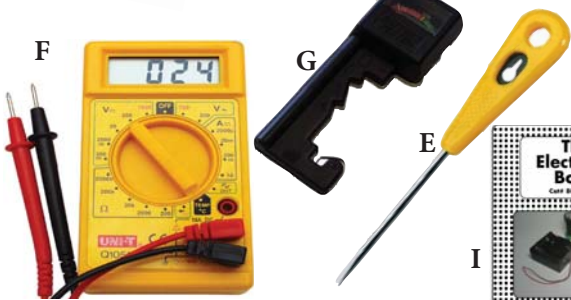

FDigital Multi Meter
• 7 functions, 19 ranges
• diode & transistor tester
• DC & AC voltage
• DC current
• Resistance
• Temperature
• Self battery test
CAT# 80-3KW140\$24.55

G....Battery Tester
The colour scale indicates if the battery condition is good, low or ready to be replaced.
CAT# 70-3200-00\$11.25

H..... Wire Stripper (Automatic)
This wire stripper is ideal for any and all electricity projects using multi or solid core wire. Fits AWG 18, 14, 12, 10, 8
CAT# 83-1136-25.....\$14.00 EA (2+ \$12.25)

I The Electricity Book
An introduction to simple circuits and making your own switches with plenty of illustrated examples to stimulate classroom activities, including bulbs, motors, buzzers and batteries. 20 pages
CAT# 80-5700-17\$10.50



J.....DC Power Supply
Forget the batteries! This safe and reliable power supply is a convenient source of low voltage DC power. Dial easily turns to select the desired voltage and it plugs into a standard electrical outlet. 3V-12V DC, 1.25 amps max.
CAT# 80-4851-00.....\$95.50

Battery Holders

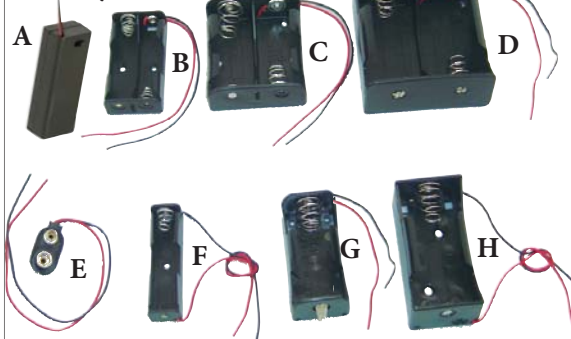

Fig	Cat#	Description	1	2-5	6+
A	70-32142SW	Double AA Holder w/ on/off switch	\$1.49	\$1.35	\$1.22
B	70-32-142	Double AA Cell w/leads 3V ea	\$1.08	\$0.90	\$0.81
C	70-32-170	Double C Cell w/leads 3V ea	\$1.32	\$1.10	\$0.99
D	70-32-177	Double D Cell w/leads 3V ea	\$1.50	\$1.25	\$1.13
E	70-32-236	9V Strap 6/pkg	\$2.40	\$2.35	\$2.20
F	70-32-178	"AA" Cell Single 1.5V 10/pkg	\$6.60	\$6.05	-
G	70-32-179	"C" Cell Single 1.5V 10/pkg	\$9.80	\$8.20	\$7.20
H	70-32-180	"D" Cell Single 1.5V 10/pkg	\$9.90	\$8.80	\$8.00

Alkaline Batteries

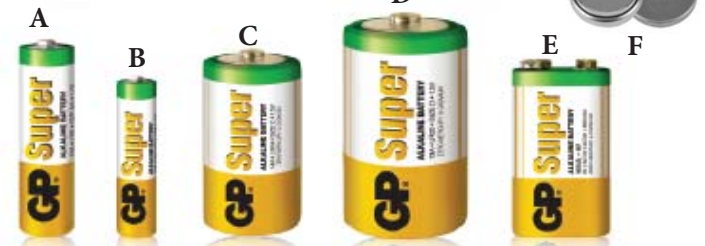

Fig	Cat#	Description	1	2-5	6-19	20-49	50+
A	70-3201-00	AA Alkaline	\$0.89	\$0.84	\$0.74	\$0.63	\$0.53
B	70-3211-00	AAA Alkaline	\$1.40	\$1.20	\$1.15	\$1.05	\$1.00
C	70-3203-00	C Alkaline	\$1.60	\$1.40	-	-	-
D	70-3205-00	D Alkaline	\$2.50	\$2.20	\$1.87	\$1.76	1.65
E	70-3209-00	9 Volt Alkaline	\$2.75	\$2.50	\$2.20	\$2.05	-
F	70-3216-00	3V Lithium 5/pkg	\$2.10	\$1.95	-	-	-

KIDDER reserves the right to substitute for equal value

Electric Paint and Activities



Fig	Cat#	Description	Price
A	8035-CEPP	Electric Paint Pen 10 mL	\$15.25
B	8035-CEPJ	Electric Paint Jar 50 mL	\$44.30
C	8035-CFPA	Flashing Card Power Animals	\$34.60
D	8035-CFCC	Flashing Card Celebration Circuit	\$34.60
E	8035-CFCE	Flashing Card Conductive Encounters	\$34.60
F	8035-CFMR	Flashing Card Merry Resistivities	\$34.60
G	8035-CGHS	Glowing House Set	\$46.15
H	8035-TBSK	Touch Board Starter Kit	\$268.00

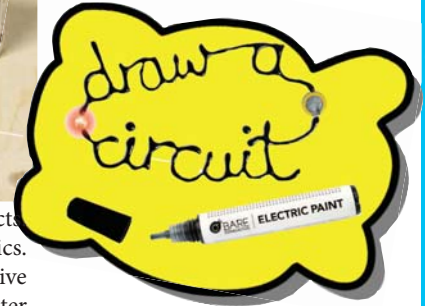

You can use Electric Paint for a range of applications, from creative to highly technical projects. It provides a great platform for discovering, playing, repairing and designing with electronics. Electric Paint can be used as a liquid wire to draw or print graphical circuits, or even as a conductive adhesive eliminating the need for soldering equipment. It is non-toxic, solvent free and water soluble. This makes it great for use at home or in the classroom.

C - F. Flashing Card Sets
Bring these cards to life. Each set comes with 3 cards, an electric paint pen, 3 batteries and 3 x LEDs.

G. Glowing House Set
As the light fades your houses will start to glow! Set comes with house templates with scenery, 2 x 9-volt batteries, 9-volt straps, leds and electric paint pen.

H. Touch Board Starter Kit
The Touch Board Starter Kit comes ready to plug in and play and is supported by a printed Guidebook, three sample projects, tutorials and digital resources. It provides inspiration for a varying scale of complexity, from the creation of responsive wall graphics and audio reminders, to alarms.



Assorted - ENGbox™ Pulley & Gears, Electricity, Wheels



Head to www.kidder.ca now to see more information on these kits!

Pulley & Gears ENGbox
This 325 piece kit includes an assortment of plastic pulleys, gears, gear racks, worm gears, o-rings, and dowel. It includes an organizing tray.

CAT#8354ENGBXP...\$145.00

Electricity ENGbox
This 130 piece kit includes an assortment of light bulbs, LED's, battery holders, switches, motors, and bulb holders. Int includes an organizing tray.

CAT# 8354ENGBXE...\$185.00

Wheels ENGbox
This 600 piece kit includes an assortment of wheels in plastic, mdf, card stock and axles, dowel, and screw eyes. It includes an organizing tray

CAT# 8354ENGBXW...\$110.00

Electricity Kit



CAT# 80-54-3201
\$180.00

Kit Includes:

- 15 Bulb Holders w/ Fahnstock clips
- 15 Miniature bulbs, 2.5V
- 15 switches w/ Fahnstock -clips
- 15 'D' Batteries, 1.5V
- 15 Battery holders, 1x 'D' for w/s/p connections
- 3 Leadwire set/10
- 2 Mini motors
- 2 Buzzers
- Caddy with cover
- Instruction manual

Series & Parallel Circuits Kit

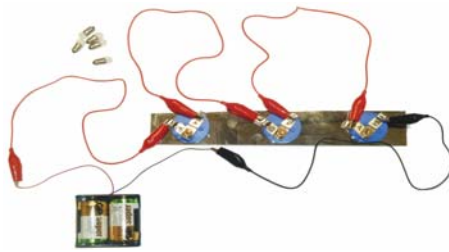

CAT# 80-54-3310.....\$16.95

What are "Series" & "Parallel Circuits"? Circuits consisting of just one battery and one load resistance are very simple to analyze, but they are not often found in practical applications. Usually, we find circuits where more than two components are connected together. Kidder has created a kit that will help teachers get their message across to students about the characteristics of electricity. (Batteries & all leads included)

Conductivity Tester

new



Kidder has created a device that is able to detect the conductivity of certain rocks, minerals and just about any inanimate object/material. Place both ends of the alligator lead to the object and if the buzzer goes off it is conductive! Simple as that. *Rocks & 9V battery not included*

CAT# 80-54-3390.....\$7.00 (2+ \$6.50)

Friction Rod



Use these rods for creating frictional electricity with materials like silk, wool, fur for charging electroscopes etc. Approximate dimensions of solid rods are: 250-300(L) x 10-13(Dia.)mm. Sold individually.

- Ebonite - CAT# 80-3562-01.....\$3.60
- Glass - CAT# 80-3562-02.....\$3.40
- Acrylic - CAT# 80-3562-03.....\$3.40

Magleads 10/pkg



Make working electrical circuits instantly with these ingenious leads fitted with a tiny yet powerful magnet at both ends. Place near to a battery case and it connects by itself, place next to a bulb holder connector and you have your first working circuit. The magnets at 4 mm in diameter and will work in all the places that standard clips work. Magleads® can be daisy chained together to extend their length with ease. Sold 10/pkg

- Black - CAT#80-3561552..\$30.80
- Red - CAT#80-3561553..\$30.80

Rainbow LEDs

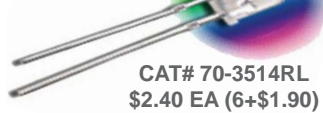

CAT# 70-3514RL
\$2.40 EA (6+ \$1.90)

Slowly cycles through a spectrum of colours when connected to a 3 volt battery. Easy to integrate into project work, these LED's will help to stimulate pupils and encourage creative design outcomes. (see 3V batteries on pg. 18)

Black Electrical Tape



Adhesive backed Electrical tape. Each roll is 3/4in. Wide, 66ft. long & .007in. thick. Rated for: <600V and <80°C use. CSA approved.
CAT# 83-1721-00\$1.68 (2+ \$1.48)

Copper Strip Electrode

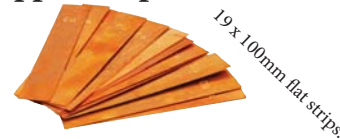

19 x 100mm flat strips.
CAT# 80-3560-97.....\$1.75 EA (6+.. \$1.30)

Zinc Strip Electrode



19 x 100mm flat, batter electrode.
CAT# 80-3560-98.....\$1.65 (6+.. \$1.20)

TRONIX LAB 1

new



Tronix Lab 1 starts students on the journey to learn the basics of circuits, resistors, potentiometers, and diodes as well as voltage, resistance, current, and more as they create fun projects such as a burglar alarm, a police siren, and a Morse code machine. Includes a well-illustrated manual with 40 lessons, more than 50 electronics components, a solderless circuit board, and a 9 V battery. No soldering required.

CAT# 8054TNX-L1.....\$66.50

TRONIX LAB 2

new



39 lessons and hands-on experiments to introduce digital electronics to your students. Each experiment is complete with a lesson showing drawings and diagrams explaining the concepts of digital electronics. Covers CMOS and linear Op Amp IC's gates, flip flops, schmitt triggers, shift registers and more. Circuits to build and experiments include Logic, Counters, Digital Read-Outs, Chaser Lights, Light Activated Counter and more.lete with everything needed including battery and manual.

CAT# 8054TNX-L2.....\$89.00

TRONIX LAB 3

new



Complete students' introduction to electronics with an understanding of oscillators and amplifiers - key to television and radio transmissions, computer and quartz clocks, and video game audio. This lab is broken down into five in-depth lessons: Vacuum Tubes and Transistors, Transistors as Amplifiers, Audio Amplifying Systems, Transistors in Oscillators, and Oscillator Applications. Includes an illustrated lab manual, more than 25 electronics components, battery snap, push button, potentiometer, speaker, crystal mic, solderless circuit board, and a 9 V battery. No soldering required.

CAT# 8054TNX-L3.....\$85.50

Make your own switch!

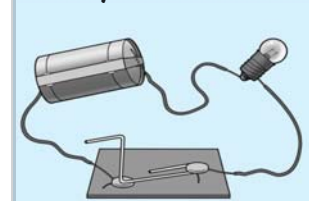

1" Brass Connectors



CAT# 83-1620-00
\$1.75.....25/PKG

Paper Clips



CAT# 83-1612-00
\$1.63.....200/PKG

Hand Generator Kit

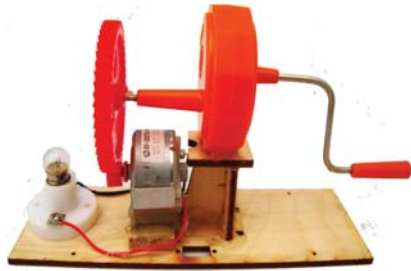

Just wind the motor and watch the light bulb illuminate. Find out first hand how the RPM speed directly effects amount of power going into the circuit. Some gluing required.

Single Kits (Packaged)

CAT# 80-5434-SK.....\$21.95

20 Student Class Pack

CAT# 80-5434-00.....\$395.00

Pieces to build 20 hand generators.

Solar Kit



A kit comprising 400 mA solar module, low-inertial DC motor, connecting lead, fan impeller and selection of turntable discs. Supplied complete with booklet explaining the principles and applications of solar energy, this kit is an ideal educational introduction to solar power.

CAT# 80-3598823.....\$34.15 (2+ \$31.05)

Solar Power Kit



- 150 Challenging Experiments.
- Convert solar energy.
- Build a solar electric generator, motor, water heater, furnace, thermometer, crane and solar energy mobiles.
- Unique experiments with colour optics, electroplating, stroboscopes, thermodynamics and Moiré patterns.

CAT# 80-3568300.....\$45.25

Solar Cell

Encapsulated mini solar panel with 6" red and black leads (no soldering required). Great for science projects or solar energy lessons. Connect together in series to increase voltage, in parallel to increase current. Output is 1.5 volts, 500mA. 3.75" X 2.5".

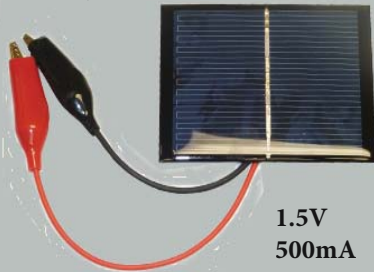

1.5V
500mA

CAT# 80-3568-35.....\$16.65
(2-5 \$15.20, 6+ \$14.25)

Power Generator Kit



30 Student
Class Pack!

Students will become engineers by using their creative problem-solving skills to design, build and test an electrical-mechanical system powered by a hand crank. In this lesson, students will explore forces, form, function and mechanical efficiency by constructing a hand crank power generator. Pack includes enough materials to build 30 kits.

CAT# 80-54-PWGN.....\$145.00

Solar Car Class Pack



This new solar car kit works well in bright sunlight and demonstrates the science of solar energy. This car is gear driven.

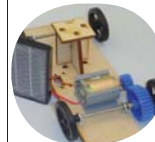

Single Kits (Packaged)

CAT# 80-5438-SK \$24.95

12 Student Class Pack

CAT# 80-5438-00 \$280.00

Snap Circuits Alternate Energy Kit



CAT# 80-3503125.....\$102.00

Learn about energy sources and how to "think green". Build over 125 projects, using the flexibility of our award-winning Snap Circuits®, to have loads of fun learning about environmentally friendly energy and how the electricity in your home works. Includes full colour manual with over 100 pages and separate educational manual. The educational manual will explain all the forms of environmentally friendly energy including: geothermal, hydrogen fuel cells, wind, solar, tidal, hydro, and others.

Electric Energy Demo Set



Students can experiment with this kit to discover for themselves how energy exists in many forms and the resources from which society can benefit. Some examples include mechanical, chemical, light, and wind. Harnessing these forms and converting them into electricity creates easier ways of accomplishing many tasks. Kit comes with a helpful manual.

CAT# 80-351113.....\$113.50 (2+ \$107.50)

Halogen Light



- 500w Portable Halogen Light
- A perfect light source to operate any of Kidder's Solar powered kits.

CAT# 83-1120-75.....\$24.30

Solar Propeller

Plastic, 2mm hole, 4 blades (5 cm diameter). Ideal for use with Solar Motor



6/pkg
CAT# 80-3554-00.....\$12.00

USING WIND ENERGY



A- Advanced Wind Experiment Kit

Discover advanced aspects of wind turbine technology. Test different blade designs, gear ratios, generators, and devices to measure electrical and weightlifting power. Discover advanced concepts of wind turbine technology! Young scientists can explore gearboxes and airfoils. They can also construct blades to generate electricity, lift weights, and pump water. This kit is perfect for grades 7-12 and is all inclusive. You will need your own wind source, basic tools, and imagination!

CAT # 80-3KW5409.....\$163.00

Kit Includes

- | | |
|---------------------------------------|---------------------------------------|
| 1 x Wind Turbine Generator with Wires | 1 x Blade Pitch Protractor |
| 1 x Weightlifter Nacelle Parts | 25 x Dowels |
| 1 x Wind Turbine Hub | 1 x Power Output Pack |
| 1 x Power Output Board | 5 x 3" x 12" x 3/32" Balsa Wood Sheet |
| 1 x Tower & base | 10 x 3" x 12" Chipboard Blade Sheet |
| 1 x Plastic Weightlifter Bucket | 1 x 4' String |

Supplies can also be order separately (see below).

B..... 12 Hole Hub (Fits a 2mm shaft motor)

The hub will press fit onto the shaft of many small DC generators; just attach your own blades and begin experimenting with wind power! The hub is designed to allow you to change blade angles and/or interchange blade sets quickly and easily. It will fit up to 12 1/4" dowels.

CAT# 80-3KW005.QTY 1 \$14.70, 2-5 \$14.00 6-UP \$12.60 EA

C..... Wind Generator Motor

This is the primary generator for wind turbine experiments because it runs smoothly and provides high power output at a relatively low RPM. This generator has 4-foot leads which are attached with shrink-wrapped, reinforced soldering. Typical output in non-g geared wind devices is 0.5-2.5 V at 0.1-0.3 A.

CAT# 80-3KW050.QTY 1 \$14.50, 2-UP \$12.70 EA

D..... High Torque Motor

The High Torque Generator is another option for your wind turbine generator. When compared to the standard Wind Turbine Generator, this High Torque Generator will produce lower voltage but higher current for a given rotor RPM. The High Torque Generator is great for load devices with higher current draw, such as the water pump. This generator has the same 2 mm driveshaft as the standard Wind Turbine Generator, so the Wind Turbine Hub is interchangeable with either motor.

CAT# 80-3KW055 .QTY 1 \$10.15, 2-UP \$9.55 EA

E..... Gear Set

Experiment with gear ratios on your wind turbine or other small projects. Adding gears to your turbine can greatly increase the generator RPM, giving you higher power output. The small 8-tooth gear fits on 2 mm driveshafts that are found on many DC generators. The gears have a keying feature that allows them to be changed quickly and easily using the included hex locks. The hex lock secures to our 9/64 inch hex-driveshaft. Hex-driveshaft not included. Spool used as a lift device

Gear sizes: 64 teeth, 32 teeth, 16 teeth, 8 teeth.
CAT# 80-3KW065.....\$17.80 SET

F..... 7/64" Diam. Drive Shafts

These can be attached to your hub(some drilling required) to use to make blades. 6" long

CAT# 80-3KW095..... \$14.35 EA

G..... Balsa Wood

Use these balsa sheets as blade material. The sheets are 3/32" by 18" long

CAT# 83-AW404..... \$13.25 6/PKG

HDowel

These dowels are used for designing and testing wind turbine blades, and they fit into the turbine hub. Students can design blades using materials like balsa wood or chipboard sheets, and attach their blades to the 1/4-inch dowels using glue or tape. The dowels are 1/4"x 24" sold 8/pkg

CAT# 83-2004-02.....\$5.00 8/PKG

I..... CoroplastTM

This corrugated plastic can be used for blade material. The sheets are 4mm x 7.5cm x 40 cm . 16/pkg (See full sheets on page 27)

80-1203-16.....\$7.25 16/PKG

J..... Blade Pitch Protractor

This tool makes blade pitch experiments much easier! The Blade Pitch Protractor has a cut-out notch to fit around the blade dowel, and it has ridges on the back that align with the KidWind hub, making it perfect for reading, measuring, and comparing blade pitch angles.

80-3KW259 QTY 1 \$9.15, 2-5 \$7.30

K..... Digital Multimeter/Tester

Use this digital meter to view output voltage.

CAT# 80-3KW140..... QTY 1 \$24.55, 2-UP \$22.10

L Power Output Board

This power output board includes a visual voltmeter, LEDs, resistors, a capacitor, and a sound generator. This device makes it very easy to demonstrate and measure the power output of your small wind turbines or solar panels. This is a great way to demonstrate power output from small electrical devices

CAT# 80-3KW113.....\$59.50

M.... Water Pump

This low voltage water pump is a great way to demonstrate power output from the wind and solar kits. It makes comparing different turbine designs easy; simply measure how high different turbines can pump water using this mini pump.

CAT# 80-3KW180 QTY 1 \$18.20 2-UP \$17.65

N..... 20" Box Fan

This fan has 3-speed settings and a reinforced grille for safety and durability.

CAT# 80-3KWFEAN.....\$44.95

O..... Wood Tower with Base

Use this tower to easily build your wind turbine. The turbine head fits easily on the top of the stand. You can even paint it. Tower is 20" tall and the base is 17" in diameter.

CAT# 80-3KW250..... QTY 1 \$19.85, 2-5 \$18.50 6-UP \$16.15

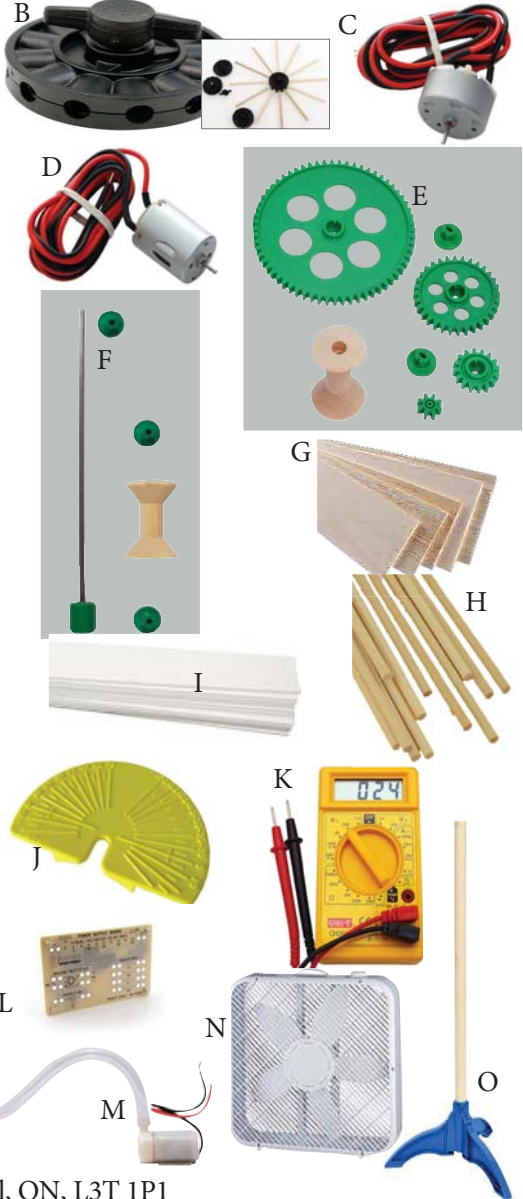

See more load activities, buzzers, LEDs, etc on pages 16 & 17

Unit#3-39 Glen Cameron Road, Thornhill, ON, L3T 1P1

Prices are subject to change without notice

Ceramic Magnets

These magnets are 1" x 3/4" and are excellent for use in magnetic levitation projects.



CAT# 80-3560-00 \$18.90 50/PKG

Ceramic Bar Magnets



These ceramic bar magnets are composed of strontium carbonate and iron oxide and have coated marked poles. They are 1" x 3/8" x 1/4". 10/pkg

CAT# 80-3560-23.....\$7.50 10/PKG

Mag-Lev Cars Student Class Pack

- Kit includes the parts to build your magnetic levitation cars (excluding body material).
30 Student Class Pack
- 5 x 80-3550 3-9V Input Toy Motor 6/pkg
 - 5 x 80-3555 3" Plastic Propellers 6/pkg
 - 3 x 80-3560 Magnets 50/pkg
 - 1 x 80-5747 Procedure Sheet



CAT# 80-5450-00\$125.00

Mag-Lev Track

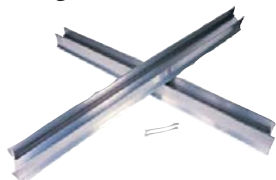

The Maglev Track includes two aluminum 4' tracks, as well as four 4' strips of magnet that act to repel your car and keep it in the air. Includes two pins to hold two track pieces together. Dimensions: 4' x 3 3/4" sections.

CAT# 80-5454-00.....\$435.00

Powerful Rare-Earth Magnets

You will find many uses for these powerful magnets. The lifting capacity for the 1/4" magnet is 2.5 lbs and for the 1" magnet 30 lbs.



Cat#	Size	Pkg	Price
CAT# 80-35MAG14	1/4" x 1/10"	20/pkg	\$11.95
CAT# 80-35MAG38	3/8" x 1/10"	10/pkg	\$8.20
CAT# 80-35MAG12	1/2" x 1/8"	10/pkg	\$14.60
CAT# 80-35MAG10	1" x 1/8"	5/pkg	\$22.65

U-Shaped Magnets



These u-shaped magnets are 10 x 17cm and include keepers. The poles are marked.

CAT# 80-3559-42...\$19.80 (6+ \$16.20)

Bar Magnets Steel



These magnets are useful for demonstration, plotting magnetic fields. They are made from magnetic steel strips. The ends are painted red and stamped with 'N' and 'S' to indicate north and south poles. Supplied in pairs with cardboard separator and plated soft iron keepers. 100 x 12 x 5mm

CAT# 80-3559-47.....\$4.50 EA

50 ft Flexible Magnetic Strip

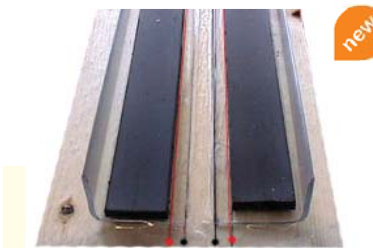

Flexible Magnetic High Energy Strip with adhesive (1.1)0.125"THK x 0.500"W can be magged B/P, M/P, or T/T Flexible Magnetic High Energy Strip - 1.1 MGOe Energy Thickness x Width: 0.125" x 50 ft This material is sold in 50 ft lengths, Plain, Pressure Sensitive Laminating Available. Perfect for your MAG LEV track!

CAT# 80-3560FLX\$98.00

Electromagnetism Kit

With this kit you can compare an electromagnet to a normal magnet and it also demonstrates electric circuit.

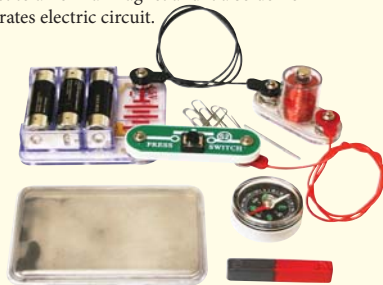

CAT# 80-35SCP08.....\$23.05

Iron Fillings In Plastic



Iron Fillings in a sealed Clear Rectangular Case. See how iron filings react with magnets and show magnetic fields without the mess.

CAT# 80-3560-70.....\$14.85

Iron Fillings in Shaker



Iron filings (grease free) in plastic bottles. 200g

CAT#80-3560-80.....\$8.00

Natural Loadstone



This nature magnetic loadstone is 2.5cm and is sold 10/pkg.

CAT#80-3560-92....\$14.70 10/PKG

Magnetic Marbles



This nature magnetic loadstone is 2.5cm and is sold 10/pkg.

CAT# 80-3559-60.....\$3.90

Magnetic Levitation Kit



Learn about equilibrium and magnetic fields while constructing a gravity-defying train. Kit includes: disc, ring, latch and neodymium magnets, standard and hi-force magnetic strips, plastic guide rails, compass, iron filings, wood blocks, nails and experiment and project book. Ages 10+

CAT# 80-54-3560.....\$59.00

Magnets in Motion Kit



Learn about equilibrium and magnetic fields while constructing a gravity-defying train. Kit includes: disc, ring, latch and neodymium magnets, standard and hi-force magnetic strips, plastic guide rails, compass, iron filings, wood blocks, nails and experiment and project book. Ages 10+

CAT# 80-54-3563.....\$65.50

Electromagnetic Kit

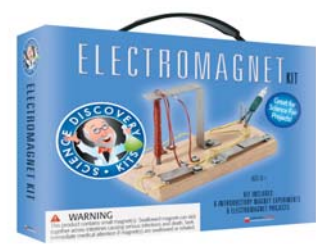

Build a doorbell, telegraph system and even a catapult all using a true electromagnet. Kit includes: disc, latch and neodymium magnets, compass, straws, wires, sand paper, switch plates, wood screws, nails, light bulbs, battery holders, iron filings, pre-drilled wood blocks, light emitting diode (LED) and experiment and project book. Ages 10+

CAT# 80-54-3562.....\$62.50

Electric Motor Generator

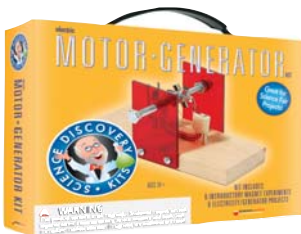

Explore the wonders of electricity by building a motor/generator that actually powers a light bulb. Kit includes: disc, latch and neodymium magnets, compass, wire, sand paper, spring, paper clips, pre-drilled wood block, iron cores, nuts, nails, screws, bolts, light emitting diode (LED), plastic plates and tubes and experiment and project book.

CAT# 80-54-3561.....\$62.50

Floating Magnet Ring Set



Demonstrate how magnetic poles repel each other by placing three or more rings on the pole. This set comprises of five coloured ring magnets (32 x 18 x 6mm) magnetized parallel to the axis and is equipped with an acrylic rod mounted on a non-magnetic plastic base.

CAT# 80-3560-27..... \$11.75 (6+ \$9.25)

Magnet Motor Kit



Assemble a simple motor that keeps a wire coil spinning...and spinning! Includes: magnet, plastic battery case, metal supports, wire coil and activity booklet.

CAT# 80-54-3565.....\$14.40

Magic Bullet Train



The Magic Bullet Train is Kidders answer to the fine craft of model-building - and practically from scratch! The Magic Bullet Train includes all the raw materials needed to construct the track and a block of balsa wood that can be shaped into your own custom train! Also included in the kit are ring magnets and a dowel so children can learn the theory of levitation behind the real-life maglev trains! Kit does NOT include wood glue, paint, primer and sandpaper needed to shape and design. (See pg. 27 for glue)

CAT# 80-54-3566.....\$35.20

MAGNET Classroom Attractions Level 3



This classroom kit contains: 5 Alnico bars, 5 Alnico horseshoe magnets, 5 flexible magnet discs, 5 compasses, 5 corks, 5 dowels, 5 nails, 5 Lodestones, 5 pieces, magnetic viewing film, 5 sets iron filings, 5 button magnets, 10 block magnets, 10 disc magnets, demo bar magnet, and a teacher activity guide. Grades 4 - 6. Ages 9 - 12.

CAT# 80-54-3567.....\$154.50

Hip Roof House Framing Kit

This 3/4" scale kit for a two bedroom home with a Hip roof teaches sound wood frame construction in accordance with accepted building codes. The kit comes complete with Balsa wood, cutting tools, measuring tape, layout pencil, nails, custom miter fixture, instruction booklet, nine working drawings and a work base that doubles as a foundation for the completed model. All of the walls can be framed right on their patterns on the working drawings. The completed model includes a bathroom, kitchen, hallway, dining and living rooms. Foot pad - approx. 1-1/2'k x 2'k. Grades 6 - 12.



CAT# 83-541001C Hip Roof House Framing Kit.....\$176.50
 CAT# 8354R1001C Replacements Parts Only.....\$74.00

Truss Roof House Framing Kit

This 3/4" scale kit for a two bedroom home with a Truss roof teaches sound wood frame construction in accordance with accepted building codes. The kit comes complete with Balsa wood, cutting tools, measuring tape, layout pencil, nails, custom miter fixture, instruction booklet, nine working drawings and a work base that doubles as a foundation for the completed model. All of the walls can be framed right on their patterns on the working drawings. The completed model includes a bathroom, kitchen, hallway, dining and living rooms. Foot pad - approx. 1-1/2'k x 2'k. Grades 6 - 12.



CAT# 83-541041C Truss Roof House Framing Kit.....\$176.50
 CAT# 8354R1041C Replacement parts only.....\$74.00

Trebuchet Kits



This model is a tabletop working replica of a trebuchet made in the 13th Century. Standing 26 inches (67 cm) tall by 18 inches (48 cm wide) this model will shoot balls of plasticine (included) over 20 feet! Please be careful of what (or whom) you take aim on, this thing can really let loose. All you need to make the model is some glue and a good pair of scissors.

- Model is pre-cut and each joint is drilled for super strong connection.
- Comes with a leather-like sling and some soft modelling clay for safe hurling!
- Has an excellent, easy to read and understand building manual with 19 clear illustrations.
- Can be built in 1 to 2 hours with little modelling experience needed

CAT# 83-5400101.....\$28.20



Basswood Building Strips

These architectural model builders wood can be used to build miniature houses and other buildings. They are sold 50/pkg and are 24" (61cm) in length.



Model home projects courtesy of Mr. Medhat Tadras who teaches technology studies at Westmount S.S. in Thornhill.

Bass & Balsa Wood (Jinks)



BASS WOOD STRIPS 61 cm length (24") \$/Pkg of 100

Cat#	Size	1	2-5	6+
83-BW058	5 mm x 8 mm (3/16" x 5/16")	\$49.70	\$48.25	\$45.60
83-BW0510	5 mm x 10 mm (3/16" x 3/8")	\$52.50	\$51.50	\$48.75
83-BW044	3 mm x 3 mm (1/8" x 1/8")	\$39.90	\$38.00	\$32.30
83-BW055	5 mm x 5 mm (3/16" x 3/16")	\$46.20	\$44.00	\$41.80
83-BW066	6 mm X 6 mm (1/4" x 1/4")	\$46.20	\$44.00	\$41.80
83-BW088	8 mm X 8 mm (5/16" x 5/16")	\$49.70	\$48.25	45.60
83-BW1010	10 mm x 10 mm (3/8" x 3/8")	\$51.00	\$49.50	\$46.50
83-BW1212	12mm x 12mm (1/2" x 1/2")	\$58.00	\$54.50	-

BALSA WOOD STRIPS 61 cm length (24") \$/Pkg of 100

Cat#	Size	1	2-5	6+
83-AW044	3 mm x 3 mm (1/8" x 1/8")	\$29.25	\$26.00	\$23.40
83-AW055	5 mm x 5 mm (3/16" x 3/16")	\$37.35	\$34.85	\$28.20
83-AW066	6 mm X 6 mm (1/4" x 1/4")	\$44.10	\$42.00	\$35.70

Actual Sizes

Fig	Cat#	Size	Represents	1	2-5
A	83-BW0412	4mm x 12mm	2' x 8' Joist	\$27.00	\$25.00
B	83-BW0409	4mm x 9mm	2' x 6' Joist	\$25.00	\$22.50
C	83-BW0406	4mm x 6mm	2' x 4' Joist	\$27.00	\$25.00



GLUE ON PAGE 27

Balsa Tower Kit Class Pack

This Kit stimulates your students to succeed with this new hands-on, tower-building challenge! Creative, problem-solving kit includes construction concepts plus design secrets. Using premium balsa wood, students fashion lap or butt joints to create symmetrical, winning prototypes. Includes 360 Balsa strips of 1/8" x 1/8" x 24", "B" sized graph paper sheets, bottle's of tacky formula glue, student instructions & teacher's manual.

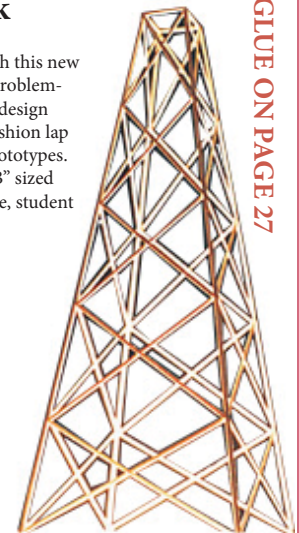

24 Student Tower Kit Class Pack
 CAT# 80-548655X.....\$105.50

Balsa Wood Strips
 1/8" x 24" 100/pkg
 CAT# 83-AW044...\$29.25

Toll Free 1.800.263.3556 • Toll Free Fax 1.800.731.8424 • www.kidder.ca

Prices are subject to change without notice

STEM: Technology & Engineering

DA VINCI



Da Vinci Bridge

new

The Leonardo Emergency Bridge is finally here! Designed to be set up and removed quickly by armies (Lego armies for this bridge). This is a simple kit, yet elegant in design, and one of his many designs.

CAT# 83-5400D29.....\$12.90



Da Vinci Catapult

new

While the Medieval catapult we made uses the force of twisted rope, this uses the tension stored in bent wood to hurl objects – usually over 15 feet. With no modifications you can experiment with flinging grapes, and those fun mini marshmallows too! A great way to introduce graphing for kids!

CAT# 83-5400D17.....\$20.50



Da Vinci Trebuchet

new

A great kit for beginner to intermediate model makers, this kit will throw a soft clay ball (included) well over 6 metres! Great for STEM programs and a rainy day – but it can be enjoyed on sunny or cloudy days!

CAT# 83-5400D32.....\$25.90



Da Vinci Helicopter

new

While it is often referred to as a helicopter, the premise of the lift to make it rise is more like Archimedes' screw than the rotors of a helicopter. Our model uses one of the bevel gears he drew in his codices and creates a nice 2 to 1 increase in speed of the crankshaft, so the mast spins quickly, illustrating the manner in which this machine would have worked.

A great kit for beginner to advanced model makers, this is a great way to learn about gears, flight and brings Leonardo's iconic drawing to life. This is a great project that works well and looks really cool on the shelf!

CAT# 83-5400D19.....\$23.25



Da Vinci Ornithopter

new

This kit combines DaVinci's cool flying machine with one of his bevel gear designs to make a neat working model with flapping wings and a pilot with moving arms and legs.

While it remains a mystery if his ornithopter design was ever fully made or tested at the time, there are many ideas (hanging in museums around the world!) of what it might have looked like, and we have added our ideas as well.

CAT# 83-5400D18.....\$37.95



Medieval Siege Tower

new

The Siege Tower was used by invading armies to breach the walls of the castle they were attacking. They varied in size and construction (some up to 135 feet tall!) but the one we have here is typical of the styles used from about 900 BC to the medieval times as attackers tried to get over the walls of a castle.

This incredibly sturdy tabletop model will give hours (years!) of reliable sieging around the house and backyard. Like all of our kits, this one is pegged for great strength and authenticity and will give you that cool siege feeling with the firing catapult on the top.

CAT# 83-5400211.....\$31.65



Lift Bridge Kits

This bridge uses a small handle and crankshaft to lift the center span to the top of the truss structure, allowing trolls and other vehicles to safely pass between the two ends. The kit can be mostly made without glue and taken apart for storage. Snug slot construction and accurate cutting makes this possible! The kit only requires scissors, comes complete with stickers and signs for the road, easy to follow instructions and links to learn more about levers and bridges.

CAT# 83-50LFBR .. LIFT BRIDGE KIT.....\$19.85



Swing Bridge Kits

Using a wooden bevel gear, the bridge swings open and closed, just like a real swing bridge. For ease of storage, the bridge ends can be removed easily and re-assembled again, since we use a simple, yet strong, slot construction. The kit only requires scissors, comes complete with stickers and signs for the road, easy to follow instructions and links to learn more about levers and bridges.

CAT# 83-50SWBR .. SWING BRIDGE KITS.....\$21.85

Corrugated Plastic

The name Coroplast™ applies to a wide range of extruded twinwall plastic sheet products produced from a high impact polypropylene copolymer. This corrugated plastic sheeting is excellent for making small science projects. It is light, inexpensive and easy to use. The sheets are 4mm thick in panels of 24" x 32".

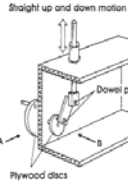

Project Idea from
Rainbow Technology
Book

CAT# 80-5739-00 7 Sheet Assorted Pack Cat
CAT# 80-54-1200 \$30.00
(KIDDER chooses the colours)

Sheets are 24"x 32" and 4mm thick.

Cat#	Colour	Price
80-1247-00	Black	\$5.20
80-1227-00	Blue	\$5.20
80-1222-00	Green	\$5.20
80-1201-00	Natural	\$5.20
80-1212-00	Red	\$5.20
80-1203-00	White	\$5.20
80-1232-00	Yellow	\$5.20
80-54-1200	7 Assorted	\$30.00

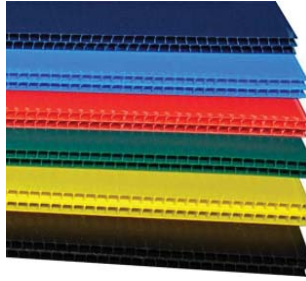

Basswood & Balsa Wood Sheets

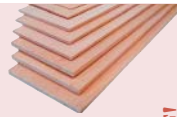

Cat#	Size	Wood	Price	2-5	6+
83-BW402	4" x 24" x 1/6"	Basswood	\$20.10	\$18.00	\$16.00
83-BW403	4" x 24" x 3/32"	Basswood	\$21.00	\$18.90	\$16.80
83-BW404	4" x 24" x 1/8"	Basswood	\$21.40	\$19.05	\$18.10
83-BW406	4" x 24" x 3/16"	Basswood	\$26.90	\$24.55	\$23.40
83-BW408	4" x 24" x 1/4"	Basswood	\$29.65	\$28.20	-
83-AW402	4" x 18" x 1/16"	Balsa Wood	\$11.50	\$10.20	-
83-AW403	4" x 18" x 3/32"	Balsa Wood	\$12.70	\$11.30	\$10.15
83-AW404	4" x 18" x 1/8"	Balsa Wood	\$13.25	\$11.75	\$10.60
83-AW406	4" x 18" x 3/8"	Balsa Wood	\$16.20	\$14.60	\$13.35

GLUE ON NEXT PAGE!

Hardwood Dowels 2' (61 cm)



If you drill a 3/8" hole, 3/8" dowel will squeak into it, not fall through it. This goes for all sizes. You can always make a tight dowel loose. Its hard to go the other way.

Cat#	Diameter	Pkg	1	2-5	6-19	20-49	50+
83-2002-02	1/8" (3 mm)	8	\$4.40	\$4.15	\$3.85	\$3.60	\$3.30
83-2002B02	5/32" (4mm)	8	\$3.70	\$3.50	\$3.25	\$3.00	\$2.80
83-2003-02	3/16" (5 mm)	8	\$4.90	\$4.60	\$4.30	\$4.00	\$3.70
83-2004-02	1/4" (6 mm)	8	\$5.00	\$4.65	\$4.45	\$4.20	-
83-2005-02	5/16" (8 mm)	8	\$6.30	\$5.85	\$5.55	-	-
83-2006-02	3/8" (10 mm)	4	\$4.80	\$4.30	\$4.00	\$3.70	\$3.40
83-2008-02	1/2" (13 mm)	4	\$5.95	\$5.45	\$5.00	\$4.50	\$4.00
83-2009-02	5/8" (16 mm)	2	\$4.10	\$3.70	\$3.30	-	-
83-2010-02	3/4" (19 mm)	2	\$3.85	\$3.50	\$3.15	-	-
83-2011-02	1" (25 mm)	2	\$5.85	\$5.45	\$5.15	\$4.90	\$4.60
83-2013-02	1 1/4" (25 mm)	2	\$11.20	\$10.45	-	-	-

(3mm acrylic rod see page 53)



A...Wood Skewers

These 2.5mm wood sticks can be used as axles in many projects. They are sold in packages of 100 pcs and are 12" long.
CAT.# 83-2001-00\$2.30
(2-UP \$2.00)

B...Balsa & Basswood Scrap Packs

Assorted strips, sheets and blocks of basswood bagged and ready for your project ideas. Each piece is 9" (23 cm) and under.
CAT# 83-AWPKG Balsa
CAT# 83-BWPKG Basswood
QTY 1 \$7.20, 2-5 \$6.65, 6+ \$6.50

C...Wooden Paddles

i. Wood Paddles 6" X 3/4"
CAT# 34-54-1013.....\$12.60 500/PKG
ii. Popsicle Sticks 4 3/8" x 3/8"
CAT# 83-1600-00.....\$4.65 1000/PKG
(*see craft sticks idea book Pg.56)

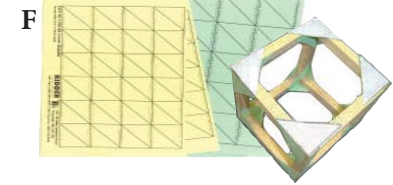

D...Brass Fasteners

Handy for making switches, fastening sheet materials, or making levers with tongue depressors or popsicle sticks. Sold 25/pkg.
CAT# 83-1620-00 1".....\$1.75

E...Headless Wood Matches

These are straight microbeams that will allow you to make some very complicate constructions.
CAT# 83-1825-00.....\$19.40 2000/PKG

F...Corner Gussets

Preprinted sheets to cut your own cardboard corners or gussets. Designed to fit the Lynx jointers and 10mm wood.
CAT# 83-1707-00 - 10mm \$7.50 1500/pkg
CAT# 83-1709-00 - 8mm \$8.15 2000/pkg

Artstraws - Excellent for Design & Technology



ARTSTRAWS are an ideal design and technology material. They are inexpensive, easy and fun to work with and very versatile. By using paper straws, rather than wood or metal, students can learn about the properties of the material and can more easily gain an understanding of basic mathematical and physical concepts (perimeter, area, tessellation, strength, rigidity, stress, stability and movement). The straws are 40cm in length (16").



CAT# 83-1804-00 4MM \$64.00 1800/BOX
CAT# 83-1806-00 6MM \$64.00 900/BOX
(Qty. discount applies)

Free D & T Idea Pamphlet Included



Toll Free 1.800.263.3556 • Toll Free Fax 1.800.731.8424 • www.kidder.ca

Prices are subject to change without notice

Mitre Box & Razor Saw

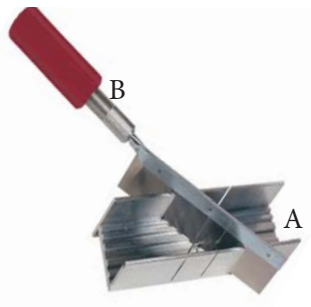

A. Mitre Box
This aluminum mitre box is just 6" long making it ideal for miniature work. Each unit has two 45° and one 90° angle cutting slots. Use with the Razor Saw set below.
CAT# 50-55665

Qty	Ea
1	\$17.10
2-UP	\$16.25

B. Razor Saw
This razor saw cuts through wood or metal (soft metal). It can be used with the above mitre box or on its own.
CAT# 50-55001

Qty	Ea
1	\$12.90

Desk Top Cutting Mats



These mats self-healing properties allow them to be used over and over without apparent damage caused by the knife. Your knife will remain sharp longer and you'll never work on a lumpy surface again.
CAT# 83-1108-00.....\$17.95
Printed with a 1cm reference grid.
24" x 17" (60cm x 45cm).

Kidder-Kut Hand Mitre w/Adjustable Fence



A fast and accurate way for cutting small wood strips to length. This tool is easy to use, with a convenient die-cast aluminum angle plate and an adjustable fence. It eliminates the need for expensive power tools. It has an adjustable fence.
CAT# 83-1126-00.... \$32.45

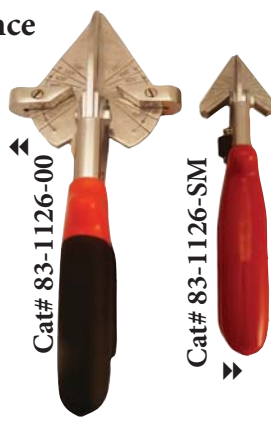

Mini Kidder-Kutter

Great for smaller hands. Similar to the Kidder Kutter but without the adjustable fence.
CAT# 83-1126-SM.....\$23.80



Replacement Blade
CAT# 83-1127-00 \$11.50

Adhesive Items

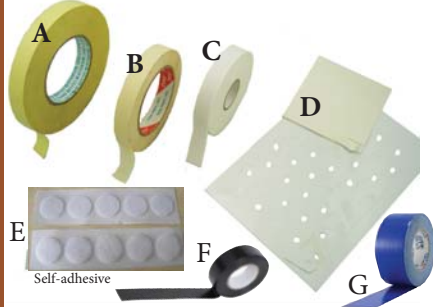

- A. CAT# 83-1711 Double Sided Sticky Tape.....\$2.25
- B. CAT# 83-1712 Masking Tape.....\$2.45
- C. CAT# 83-1713 Double Sided Foam Tape.....\$2.70
- D. CAT# 83-1708 Self-Adhesive Axles Holders.\$7.95
- E. CAT# 83-1715BUT Velcro Buttons 12/pkg...\$1.77
- F. CAT# 83-1721-00 Blk Electrical Tape 66 ft....\$1.68
- G. CAT# 83-1719-BU Blue Duct Tape 55 ft.....\$9.75

Heavy Duty Glue Gun



This heavy duty glue gun uses full size adhesive sticks. It is ideal for general repairs and light industry. It is 120V with 80 watts.

Qty	ea.
1	\$25.35
2-5	\$24.15
6 - up	\$22.95
20-49	\$21.75
50+	\$20.55

CAT# 80-480-208

Glue Sticks



10" x 3/8" 10/pkg
CAT# 80-4804580
QTY 1 \$5.95
(6+ \$4.40)
BULK
Cat# 80-4854580
\$42.60 180/pkg

← For Heavy Duty Glue Gun

Economy Glue Gun



This economical mini glue gun is perfect for small craft projects. It is 110v with 10watts.

Qty	ea.
1	\$7.25
2-5	\$6.80
6 - 19	\$6.35
20-19	\$5.95
50-UP	\$5.50

CAT# 80-480-210



4" x 5/16" 50/pkg
CAT# 80-4804450
QTY 1 \$5.40
BULK
CAT# 80-4854450
\$37.95 500/PKG

← For economy Glue Gun

(Check Low Temp glue gunes pg 31)

Contact Cement



This all purpose bonding cement works with metal, plastic, wood, leather, glass, adn many other surfaces.

30 mL Tube!

CAT# 83-1758-00....\$1.58

Glue Cups



Distribute small amounts of glue to students with these handy glue holders. They come with a lid to keep glue fresh. 10/PKG

CAT# 83-1165-00 \$1.05

Carpenter's Wood Glue

A non-toxic wood glue for design and make activities. Only a small amount is required.



- A. 83-1754-00 3.785L.....\$48.85
- B. 83-1752-00 475ML.....\$9.65
- C. 83-1748-00 120ML.....\$4.20



Superjet Glue

This is a thickened instant glue which bonds in 3-10 seconds. It is ideal for building wood structures. Use with caution.



CAT# 83-1764-00
1/2 OZ \$4.60

CAT# 83-1765-00
1 OZ \$7.75

Alumide & Wet/Dry Paper

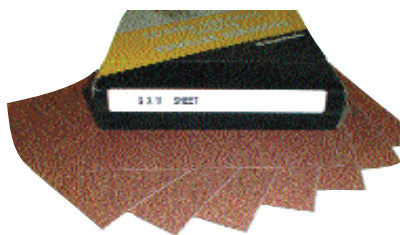

Cat#	Grit	Description	1	2+
80-2817-12	50D	Alumide	\$25.80	\$24.45
80-2817-14	80D	Alumide	\$47.55	-
80-2817-09	100C	Alumide	\$25.80	\$24.45
80-2817-03	120A	Alumide	\$25.80	\$24.45
80-2817-05	180A	Alumide	\$25.80	\$24.45
80-2817-06	220A	Alumide	\$25.80	\$24.45
80-2818-15	180C	Silicon Waterproof Paper	\$31.65	\$29.85
80-2818-01	220A	Silicon Waterproof Paper	\$59.00	-
80-2818-04	320A	Silicon Waterproof Paper	\$59.00	-
80-2818-06	400A	Silicon Waterproof Paper	\$59.00	-
80-2818-08	600A	Silicon Waterproof Paper	\$59.00	-

Crepe Abrasive Cleaner



This abrasive belt and disc cleaner, made from crepe, can triple the life of your sandpaper. When it is held against a belt or disc while in motion, it will strip out accumulated dust fibre. The block is 8" x 1.5" x 1.5" (20 x 5x 5 cm) in size.

CAT# 80-2800-00...\$12.00

Sanding Sponges

This flexible sanding sponge is ideal for corners and contoured surfaces. To clean just rinse with soap and water and reuse.



Qty	ea.
1	\$3.00
2-5	\$2.85
6+	\$2.70

CAT# 80-2804-00 Fine-Medium
CAT# 80-2805-00 Medium Course

Sanding Stick

This Sanding Stick makes sanding curves and angles on dragsters a smooth task. Sanding surface is 5" long and tapers from 1" to 1/2". The sandpaper wraps around the stick, reducing the need to turn it. Make sandpaper sheets to fit with the included templates.



CAT# 50-159.....\$9.95

Hobby File

This File has rasp cut for rough filing of wood, plywood and soft plastics and double cut for filing hard plastic, steel and formica. This is our best multi-purpose file. The length is 8" (20 cm).



CAT# 50-152.....\$20.15

Hole Punch

Ideal for use in puncturing corrugated plastic, cardstock material, paper and even leather. Case Qty (inner/outer): 24/144



CAT# 83-1130-00.....\$7.10

Needle Files

These well made needle files are a nice addition to any tool box. Each file has a nylon handle. These handy needle files come 12 per package in a folding pouch. 160mm

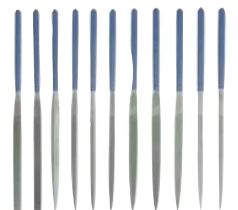

CAT# 80-3008-00.....\$12.15

200 Spring Assortment



A whole variety of Extended and Compressed Springs available in this compact, plastic organizer box.

CAT# 19-20-SPR.....\$12.25 /BOX

Cable Ties



Cable ties 8" x 100/pkg
CAT# 83-1717-00...\$4.95

Paper Drill & Cutters



For making holes in card or coroplast where an ordinary hand-held punch will not reach. Supplied with 3mm, 4mm and 6mm cutting heads.

CAT# 83-1121-00.....\$28.25

Measuring Tape



Measuring Tape 25ft/7.5m x 1in Magnetic Tip.

CAT# 83-1114-00.....\$7.55

Digital Calipers



Our digital caliper quickly displays your measurements in easy-to-see LCD numerals. It measures insides, outsides, depths and steps up to 6 inches with a resolution of .0005 inch or .01mm. 'Zero' button lets you take '2-step' measurements without calculations; another button instantly converts inches to millimeters and back again. Includes battery, instructions and foam-lined case.

CAT# 83-1149-95.....\$35.30

Fiskar's Hand Drill



CAT# 83-1133FSK...\$36.30

An ergonomically designed handle fits securely and comfortably in the palm of your hand for prolonged use without fatigue. This hand drill is especially handy for use with the fine drill bits used in bookbinding. Includes easily interchangeable drill bits, sizes 3/32", 1/8", 5/32" and 3/16". Perfect for craftspersons, students, or teachers.

Saws/Hacksaws

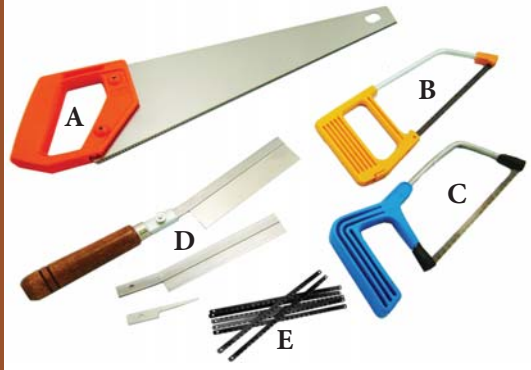

Two hacksaws that will cut through wood and not through skin! 50-235: is a basic hacksaw with a plastic handle; 50-239: has a lever to assist in changing the blade. Replacement blades Pk 10: 50-236: fine; 50-237: medium.

- A. 16 pt 14" Sandvik Saw CAT# 50-300\$22.85
- B. With Lever to assist in changing blade CAT# 50-239.\$6.70
- C. Basic hacksaw w. plastic handle CAT# 50-235.\$6.90
- D. Small Razor Saw Set CAT# 50-55001\$12.90
- E. Hacksaw Blades Med PK 10 CAT# 50-237\$4.95

Double Sided Bench Hook Mitre Box

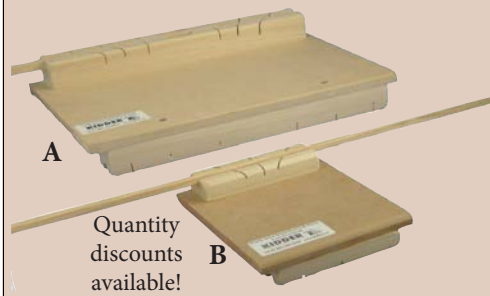

With a slot on one side for either 5mm or 8mm wood and the other for 10mm, these bench hooks are suitable for both left and right handed children.

- A. CAT# 83-1155-00.....\$18.85
13" x 8" (10mm/8mm)
- A. CAT# 83-1158-00...\$18.35
13" x 8" (10mm/10mm)
- B. CAT# 83-1150-00\$8.55
6" x 6" (10mm/8mm)
- B. CAT# 83-1150-10\$9.00
6" x 6" (10mm/10mm)

Quantity discounts available!

Basswood Jointer

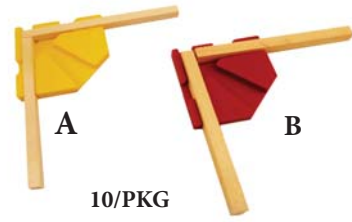

Designed by teachers these corner jointers have been copied by others many times! Designed to hold wooden strips at right-angles and 45 degrees. Both sizes are in packs of 10 and come with an instruction sheet.

- A. CAT#83-3008-00 8mm wood.....\$37.00
- B. CAT#83-3001-00 10mm wood....\$37.00

12" Metal Ruler



This ruler is handy when using an x-acto knife. A cutting mat may also be useful. It has measurements in both imperial and metric.
Cat# 83-1149-75.....\$3.00

Drill Press Vice



A vice to hold gears or wheels while drilling. Also fits onto a small drill press to hold items while drilling.
CAT# 83-1116-00...\$24.95

Rotational Vice



This rotational vice is great for holding objects so that you can work on them at any angle. (clamps to any table)

CAT# 83-1117-00.....\$26.05

Auto Retractable Utility Knife



This safety knife has an auto-retracting blade and a rubberized handle to ensure added safety when not being handled. It includes one blade.

CAT# 83-1110-AR.....\$12.70

Safety Snips



Useful snips for card, coroplast and even electrical wire. These snips are sharp and have a safety catch.

CAT# 83-1142-00.....\$12.75

Kidder-Kut Hand Mitre



A fast and accurate way for cutting small wood strips to length. This tool is easy to use, with a convenient die-cast aluminum angle plate and an adjustable fence. It eliminates the need for expensive power tools. It has an adjustable fence.

Replacement Blade
CAT# 83-1127-00
\$11.50

CAT# 83-1126-00.....\$32.45

Coping Saw

This professional quality coping saw has a sturdy steel frame. Blade tension is achieved by turning the wood handle. Easily adjustable blade fixtures and an extra narrow specially hardened blade are among the features. The blade has 5 points per inch.

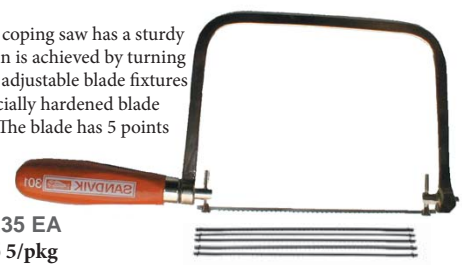

- CAT# 50-301.....\$24.35 EA
- CAT# 50-303...\$6.65 5/pkg

Clamps

A variety of clamps to hold materials when cutting and drilling.



- A. CAT# 83-1151-00 'C'-CLAMP 3".....\$6.50 EA
- A. CAT# 83-1153-00 'C'-CLAMP 4".....\$9.45 EA
- B. CAT# 83-1152-77 RATCHETING CLAMP 9".....\$7.15 EA

Mini Kidder-Kutter



Plastic coated handles for a comfortable & secure grip.

Great for smaller hands. Like the Kidder Kutter, but without the adjustable fence.
Catch allows you to lock your Trim Cutters safely closed.
Make 60°, 90° & 120° cuts
120°
90°
60°
Guides and marked angles

Replacement Blade
CAT# 83-1127-SM
\$9.85

CAT# 83-1126-SM\$23.80



A...Pliers

- i. CAT# 83-1141-00
Pliers with a cutting edge for wire.
- ii. CAT# 83-1140-00
A sturdy general purpose plier for wire or gripping.
- iii. CAT# 83-1139-00
These pliers have long flat noses for hard to reach places.

Qty	ea.
1	\$5.10
2-5	\$4.45
6-up	\$4.10

F...Desk Top Cutting Mats

Printed with a 1 cm reference grid. 24" x 17" (60 cm x 45 cm).
CAT# 83-1108-00\$17.95



B...Screwdriver Set

Hardened and tempered carbon steel blades. 9 pc set.
CAT# 83-1143-00.\$15.40

G...Spring Hammered Centre Punch

No hammer required.
CAT# 83-1101-75\$14.00

H...Safety Snips

Useful snips for card, coroplast and even electrical wire. These snips are sharp and have a safety catch.
CAT# 83-1142-00\$12.75



C...6" Adjustable Wrench

A lightweight adjustable wrench that is a useful tool to have 6" long.
CAT# 83-1144-00.\$5.90

I...Mini Kidder-Kutter

Great for smaller hands. Like the Kidder Cutter, but without the adjustable fence.
CAT# 83-1126-SM.....\$23.80



D...Hammers

- i. CAT# 83-1105-00 (16OZ).\$6.65
A wooden claw hammer to be used by more advanced students. 16oz mid-large
- ii. CAT# 83-1104-00 (8OZ)...\$7.80
A mini hammer to remove small nails or panel pins. 8oz, 26cm long.

J...Kidder Mitre Cutter

• Heavy duty steel body for long lasting use on tough materials.
• Super sharp forged steel blade that can be resharpened or replaced.
• Special handles for Non-Slip grip.
• Adjustable mitre angle
CAT# 83-1126-00\$32.45
Replacement Blades:
CAT# 83-1127-00\$11.50

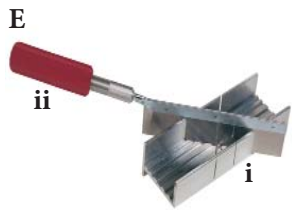

E...Mitre Box and Razor Saw

- i. CAT# 50-55665\$17.10
Mitre box made of aluminum.
- ii. CAT# 50-55001\$12.90
Razor Saw

C02 Blank Sanding Stick

This Sanding Stick makes sanding curves and angles on dragsters a smooth task. Sanding surface is 5" long and tapers from 1" to 1/2".



CAT# 50-159.....\$9.95 (2+ \$8.90)

Mini Economy Glue Gun

This economical mini glue gun is perfect for small craft projects. It is 110v with 10watts.



Qty	ea.
1	\$7.25
2-5	\$6.80
6 - 19	\$6.35
20-49	\$5.95
50+	\$5.50

CAT# 80-480-210

Low Temp Glue Gun



For elementary kid's use.

Qty	ea.
1	\$7.90
2-5	\$7.10
6 - 19	\$7.10
20+	\$6.30

CAT# 80-480-244

Heavy Duty Glue Gun

This heavy duty glue gun uses full size adhesive sticks. It is ideal for general repairs and light industry. It is 120V with 80 watts.



Qty	ea.
1	\$25.35
2-5	\$24.15
6 - up	\$22.95
20-49	\$21.75
50+	\$20.99

CAT# 80-480-208

Glue Sticks for Mini & Low Temp glue guns



4" x 5/16" 50/pkg
CAT# 80-4804450
Qty 1 \$5.40
Qty 2-5 \$4.95



Glue Sticks for Heavy Duty Glue Gun

10" x 7/16" 10/pkg
CAT# 80-4804580



Qty 1 \$5.95
Qty 2-5 \$4.95
OR BULK
CAT# 80-4854580
\$42.60 180/pkg

Toll Free 1.800.263.3556 • Toll Free Fax 1.800.731.8424 • www.kidder.ca

Prices are subject to change without notice

Manual Hand Drill



The pistol design of this drill with fully enclosed gears make it particularly suited for use in educational facilities. This model features bit storage in handle and a three jaw chuck. Chuck capacity 8mm - 3/8".

CAT# 83-1133-00\$28.30

Vertical Drill



A general purpose double pinion drill with a plastic back handle, with easy-grip feature and plated three jaw chuck. Chuck capacity 8mm - 3/8".

CAT# 83-1131-00.....\$26.45



Replacement Chuck Only
CAT# 83-1133-CK....\$7.50

Cordless Compact Drill

This drill comes with a charging base, AC adaptor, four double-ended screwdriver bits, and instruction manual.



- 18 V
- 3/8" keyless chuck
- forward reverse switch
- lightweight, ergonomic design
- 2-speeds, 200-500 RPMs
- charging base

CAT# 83-1113-00.....\$61.50

Drill Bits



This set includes 13 drill bits from 1/16" up to 1/4". Use with hand drill above. Or the cordless drill.

CAT# 83-1132-00.....\$7.00

Fiskar's Hand Drill



CAT# 83-1133FSK....\$36.30

An ergonomically designed handle fits securely and comfortably in the palm of your hand for prolonged use without fatigue. This hand drill is especially handy for use with the fine drill bits used in bookbinding. Includes easily interchangeable drill bits, sizes 3/32", 1/8", 5/32" and 3/16". Perfect for craftspersons, students, or teachers.

High Speed Steel Drill Bits



Each size
sold 5/pkg

1/16" HSS Bit
CAT# 83-1134-01\$4.50

3mm (1/8") HSS Bit
CAT# 83-1134-03\$7.30

4MM (5/32") HSS Bit
CAT# 83-1134-04\$8.40

5mm (3/16") HSS Bit
CAT# 83-1134-05\$9.75

Heavy Duty Hole Punch

This heavy duty hole punch can pierce up to 16 gauge metal. It comes with 7 punches and dies. The one hand operation creates 1 ton of pressure. Holes sizes are 3/32", 1/8", 5/32", 3/16", 7/32", 1/4" and 9/32".



CAT# 83-1128/303/32"-9/32"\$56.00

Single Hole Punch



These quality single hole punches great for home, craft, or school use. They have a 1" reach for easy positioning. They have a 10 sheet capacity. The all metal construction with metal receptacle provides durable and easy use. They are available in 1/4" or 3/16".

CAT# 83-1119-001/4" ROUND HOLE.....\$4.75
CAT# 83-1122-003/16" ROUND HOLE.....\$4.75

Stick Cutter

This unit easily cuts balsa and up to 1/8" basswood. The clear plastic shield protects the fingers. The base has 4 corner holes for mounting and a built-in protractor for angle position.

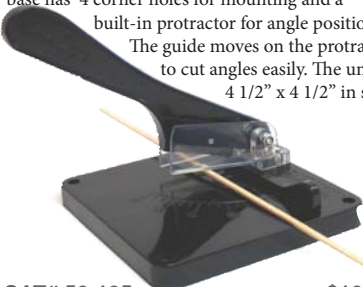

CAT# 50-105.....\$16.15

Replacement Blades
Cat# 50-105-RB...\$4.95
(Only the teacher should replace the blades on this unit.)

Table Top Cover

This hardwood table top protector keeps your work station clean and scratch free. Glue is easily removed. It is 14" x 22.5" x 1/8".



CAT# 83-1168-00 \$4.05 (2-5 \$3.70, 6+ \$3.40)

5/pkg



Sandvik Hobby File

This File has rasp cut for rough filing of wood, plywood and soft plastics and double cut for filing hard plastic, steel and formica. This is our best multi purpose file. The length is 8" (20 cm).

CAT# 50-152.....\$20.15

Coping Saw



This professional quality coping saw has a sturdy steel frame. Blade tension is achieved by turning the wood handle. Easily adjustable blade fixtures and an extra narrow specially hardened blade are among the features.

CAT # 50-301.....\$24.35

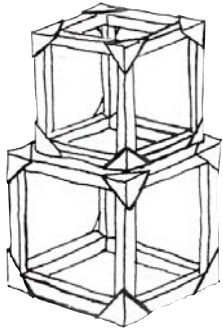

KIDDER MAKER SPACE

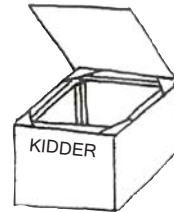
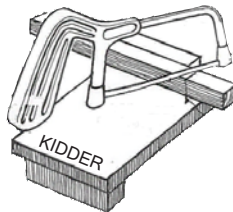
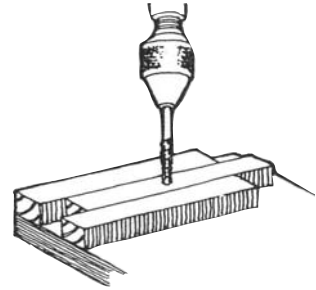

PRIMARY
CAT# 80-54MS-PR - \$279.00

new

JUNIOR
CAT# 80-54MS-JR - \$367.00

new

INTERMEDIATE
CAT# 80-54MS-IN - \$316.00

new



Educational Maker Spaces are the ideal environment for maker education. The maker movement in education is built upon the foundation of constructionism, which is the philosophy of hands-on-learning through building things. Kidder has created a MakerSpace kit for your Primary, Junior and Intermediate grade levels that are perfect for your schools that do not have a designated shop class for building and construction! If you are at the board level and are interested in purchasing these kits for a large number of schools under your authority or if you are interested in creating your own kit with tools of your choice please contact info@kidder.ca for a quote. Head to www.kidder.ca to find out what materials are in each kit.

A few MakerSpace RESOURCES

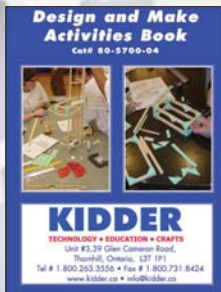

Design and Make
Activities

A photocopiable resource that contains 12 indexed sections to cover Science and Technology design and make project work. Full of ideas, challenges and hints and tips. Subjects covered include levers, electricity, hydraulic, simple machines, alternative energy and much more.

CAT# 80-5700-04....\$39.70

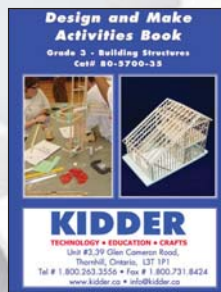

Design and Make
Activities Book Building
Structures

This book contains information on the safe use of tools, and an introduction to popular materials. There are many activities on building and testing strength design. It also includes many helpful techniques.

CAT# 80-5700-35...\$19.90

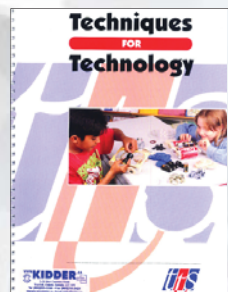

Techniques for
Technology

Students learn best through first-hand experience. Problem-solving provides opportunities for this and as such is an essential element of good practice. This book comes with hundreds of ideas for building projects pertaining to your MakerSpace kits.

CAT# 80-5700-05...\$24.95

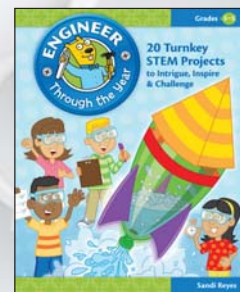

Engineer Through the
Year

20 Turnkey S.T.E.M. Projects to Intrigue, Inspire & Challenge
Is it possible to develop basic engineering skills as early as grades 3-5 without adding to the existing curriculum? You bet! The exciting challenges in this book bring out children's natural curiosity. With Engineer Through the Year, students build engineering skills all year long.

CAT# 80-5700-56....\$35.70

Toll Free 1.800.263.3556 • Toll Free Fax 1.800.731.8424 • www.kidder.ca

Prices are subject to change without notice

Cart Only (Solid Wood Plywood Construction)

Cat# 83-1107STB.....\$1153.00

Assorted Tools for Cart

Cat# 83-1107WTL.....\$530.00

Kit Includes

- 1 x Tape MeasureCat# 83-1114-00
- 1 x 4" C-ClampCat# 83-1153-00
- 2 x ScrewdriverCat# 83-1143-00
- 1 x Adjustable wrench.....Cat# 83-1144-00
- 1 x Diagonal Pliers.....Cat# 83-1141-00
- 1 x Linesman PliersCat# 83-1140-00
- 2 x Needlenose Pliers.....Cat# 83-1139-00
- 3 x 8oz HammerCat# 83-1104-00
- 3 x Large Bench Hook.....Cat# 83-1155-00
- 2 x 13pc Drill Bit.....Cat# 83-1132-00
- 4 x Basic Hacksaw.....Cat# 50-235
- 7 x Safety Goggles.....Cat# 80-3221-00
- 6 x Mini Glue Gun.....Cat# 80-480-210
- 2 x Manual Hand Drill.....Cat# 83-1133-00
- 1 x Paper Drill.....Cat# 83-1121-00
- 2 x Rotational Vise.....Cat# 83-1117-00
- 4 x Metal Ruler.....Cat# 83-1149-75
- 4 x Safety Snips.....Cat# 83-1142-00
- 30 x Glue Sticks.....Cat# 80-4804450

Mobile All Wood Tool MakerSpace

This unit comes with 6 adjustable shelves which can be removed for storage of large tools or machinery. Unit comes with locking doors. Dimensions are 40" L x 28" W x 31" H.

Perfect For Your Science Class!



You can also select your own tools!

Kidder Mobile MakerSpace

This mobile tool kit can be locked and shipped around to different locations. The demensions are 19" x 30" x 18" and is very sturdy. You can order tools and supplies including hands on manipulative material.



Mobile Cart Only

Cat# 83-1172TC.. \$110.50

Tools and Supplies Only

Cat# 83-1172WS.....\$450.00

Tools Included:

- 2 x Tape measure
- 3 x C-Clamps
- 2 x Screwdrivers
- 1 x Adjustable Wrench
- 1 x Diagonal Pliers
- 1 x Linesman Pliers
- 1 x Needle Nose Pliers
- 2 x Hammer
- 21x 3pc Drill Bit Set
- 3 x Back Hacksaw
- 6 x Safety Goggles
- 5 x Mini Glue Guns
- 2 x Manual Hand Drill
- 1 x Paper Drill w/Cutter Sets
- 3 x Metal Rulers
- 3 x Safety Snips
- 1 x Wire Cutter
- 1 x Assorted Peg Hardware/hooks
- 1 x Kidder Cutter
- 3 x Small Bench Hook
- 1 x Wood Glue
- 1 x Large Bench Hook
- 1 x Multi Hole Punch
- 1 x Bundle of Basswood
- 1 x Gussets
- 1 x Rotational Vise
- 1 x Glue Sticks



Kidders NEW MakerSpace Stations



The STEM Maker Station allows classrooms to store all of their essential maker materials in one secure place and share a unit between classrooms. Just roll your Maker Station into any classroom, lock the wheel castors into position and encourage your students to get building, tinkering and designing! The STEM Maker Station is also ideal for libraries where diverse creative activities are undertaken and space is limited. These new Kidder MakerSpace/STEM work tables are ideal for any school without a designated shop class. 2 & 4 Maker Table Stations come with powder coated top for long lasting durability. Metal drawer cabinets with plenty of room to store your basswood, tools, glue and other Maker materials! Tool Stool is very robust and fits perfectly under the station surface.

Fig.	Cat#	Description	1	2-5	6+
A	8311-50225	26" Tool Stool Unassembled	\$90.00	\$85.00	\$80.00
B	8311-542CC	10 Drawer Makers Supply Cart	\$1360	-	-
C	8311-542MT	2 Station Makers Table Station w/ stools	\$2160	\$2052	-
D	8311-544MT	4 Station Makers Table Station w/ stools	\$4345	\$4150	-
E	8311-5PLUS	Toolcubc 5 Drawer with Castors	\$720	\$680	\$640

Toll Free 1.800.263.3556 • Toll Free Fax 1.800.731.8424 • www.kidder.ca

Prices are subject to change without notice

Lab Coat



new

Made from 100% cotton. Ideal for your MakerSpaces, science and tech labs!

CAT# 83-1903-00 (MEDIUM) \$40.00
 CAT# 83-1905-00 (LARGE)...\$40.00

Glasses



These glasses have tough side shields, brow and nose bridge and one piece construction. They offer excellent comfort, strength and stability. These glasses will fit over your average prescription lenses.

Qty	ea.
1	\$4.95
2-5	\$3.95
6-19	\$3.50
20-49	\$3.20
50+	\$2.90

CAT# 80-3229-00

Goggles



General purpose goggles are important when working with any equipment and a good safety feature to stress with students. The Adult goggles will fit over your average prescription lenses.

Fig	Cat#	Description	1	2-5	6-19	20-49
B	80-3219-00	Goggles-Adult	\$3.50	\$3.20	\$3.05	\$2.75
B	80-3221-00	Goggles-Youth	\$3.50	\$3.20	\$3.05	-

Dust Mask



These disposable mask are handy for the school and home workshop. They are sold 50/ pkg.

CAT# 80-3226-00.....\$12.30 50/PKG

Denim Work Apron



Perfect to throw on over your clothes while working with wood, metal or plastic. Every Science & Tech Shop/class and MakerSpace should have a few of these Aprons handy!

Qty	\$/apron
1	\$8.40
2-5	\$8.00
20+	\$7.05

CAT# 83-1915-00

Ear Muff Hearing Protectors



CSA Class A. Tested at an independent NVLAP accredited laboratory. Ideal combination of protection, comfort and value.

CAT# 80-3227-00.....\$19.95

Cotton Working Gloves



11"

These light weight cotton work gloves are useful when working with hot glue. They are sold 6/pkg.

CAT# 70-3415-00.....\$11.50 6/PKG

Vinyl Gloves

Vinyl gloves offer a high value, dependable for those allergic to natural latex. Appropriate for short term and routine tasks involving minimal stress, Alliance vinyl gloves offer excellent tactile sensitivity which is further enhanced by their smooth surface. They are sold 100/box



Qty	\$/box
1	\$9.95
2-5	\$8.45
6+	\$7.40

CAT# 70-3419-00 LARGE
 CAT# 70-3420-00 MEDIUM
 CAT# 70-3421-00 SMALL

Ear Plugs



These ear plugs are made of tapered polyurethane and are sold 200 pairs per package.

CAT# 80-3225-00.....\$41.50 200PRS

Safe ON Science

new



Safe ON Science is STAO/APSO's newest safety resource for high school teachers. It is written by STAO/APSO's Safety Committee, a panel of experienced teachers with a strong background in science safety. Topics include legislation, general safety considerations, emergency procedures, classroom considerations and specific focus on Physics, Chemistry and Biology. Find out why several school boards across Canada rely on Safe ON Science as a core safety resource for their teachers.

CAT# 80-5710-ENENGLISH.....\$16.75
 CAT# 80-5710-FRFRENCH.....\$16.75

Safety in Science & Technology

new



This 109 page resource is the result of a partnership with TDSB. It was written by teachers for teachers and administrators, to provide guidance for the safe delivery of hands-on science and technology programs to students. The planning framework used throughout the resource helps teachers to identify hazards, assess risks and make safety plans. If you want a single reference source for dealing with safety in the elementary classroom, this is the one for you.

CAT# 80-5711-00.....\$20.95

First Aid Kit

new



Ontario regulation First Aid Kit - 6 to 15 Students.

CAT# 80-3224-00.....\$67.50

Toll Free 1.800.263.3556 • Toll Free Fax 1.800.731.8424 • www.kidder.ca

Prices are subject to change without notice

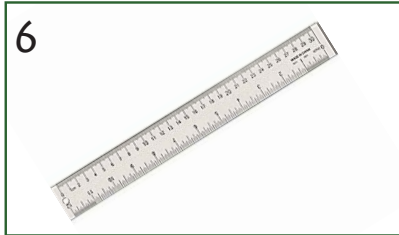

ITEM #	DESCRIPTION	CATALOG #	\$
1	Metal Thumb Tacks 150/pkg	83-1628-00	\$2.95
2	1" Brass Fasteners 25/pkg	83-1620-00	\$1.75
3	Paper Clips 200/pkg	83-1612-00	\$1.63
4	Pencil Sharpener	83-1162-SH	\$1.25
5	Pencil Eraser 6/pkg	83-1162-ER	\$1.50
6	Clear Acrylic 30cm Ruler	83-1149-85	\$1.95
7	Metal Safety Ruler 12"	83-1149-00	\$4.95

ITEM #	DESCRIPTION	CATALOG #	\$
8	Tape Measure 150cm	83-1114-FL	\$1.19
9	Foam Paint Brush Set 6/pkg	70-3430-00	\$1.95
10	9" Balloons 24/pkg	19-2025	\$4.05
11	Rubber Bands Assorted pkg.	19-2021-00	\$4.00
12	Cotton Twine	19-20-551	\$3.00
13	Collapsible Silicone Funnel	19-1234	\$2.20
14	Mini Straws 3mmx13cm 325/pkg	19-1020	\$1.90

SEE WWW.KIDDER.CA FOR QUANTITY DISCOUNTS

Toll Free 1.800.263.3556 • Toll Free Fax 1.800.731.8424 • www.kidder.ca

Prices are subject to change without notice



KIDDERAMA
"YOUR MAKERSPACE \$ STORE"

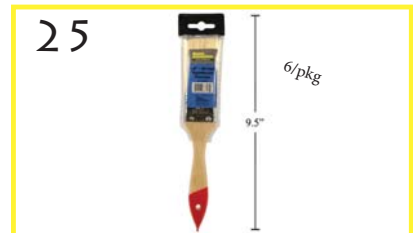
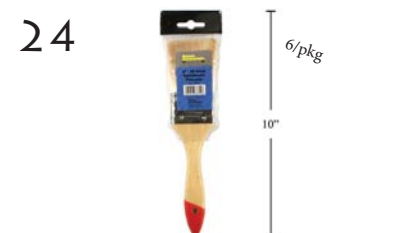

ITEM #	DESCRIPTION	CATALOG	\$
15	Flexible Straws - 100/pkg - 8"X3/16"	19-1022LGF	\$1.85
16	Plastic Beads Assorted - 60G	83-1236-00	\$1.75
17	Construction Paper - 100 sheets	83-1257-00	\$3.80
18	Pipe Cleaners - 40/pkg	83-1601-00	\$2.25
19	Plastic Spoons - 50/pkg	83-1625-00	\$2.95
20	Twist Tie Dispenser	83-1704-00	\$1.95
21	Plastic Bucket 7" w. Shovel	83-1670-00	\$1.85

ITEM #	DESCRIPTION	CATALOG #	\$
22	BBQ Lighter	83-1665-00	\$2.40
23	Paint Brush 3" - 6/pkg	70-3427-00	\$10.55
24	Paint Brush 2" - 6/pkg	70-3425-00	\$7.95
25	Paint Brush 1.5" - 6/pkg	70-3424-00	\$6.75
26	Geometry Compass Set	83-1840-00	\$2.15
27	Cotton Working Gloves - 6/pkg	70-3415-00	\$11.50
28	Plastic Cups 9 oz - 20/pkg	19-1229	\$1.80

SEE WWW.KIDDER.CA FOR QUANTITY DISCOUNTS

Toll Free 1.800.263.3556 • Toll Free Fax 1.800.731.8424 • www.kidder.ca

Prices are subject to change without notice

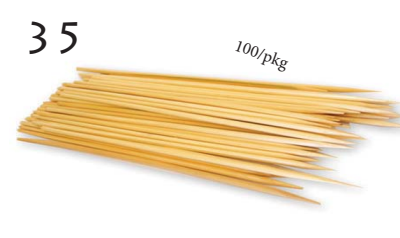
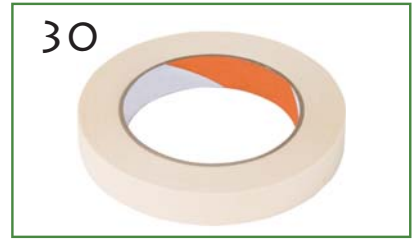

ITEM #	DESCRIPTION	CATALOG #	\$
29	Double Sided Tape - 12mmx20m	83-1711-00	\$2.25
30	Masking Tape 3/4" gen purp.	83-1712-00	\$2.45
31	Double Sided Foam Tape 30c	83-1713-00	\$2.70
32	Hook & Loop Fasteners - 12/pkg	83-1715BUT	\$1.77
33	Hook & Loop 3/4" x 96"	83-1716-00	\$17.55
34	Contact Cement Tube 1.5 oz	83-1758-00	\$1.58
35	9" Bamboo Skewers - 100/pkg	83-2001-00	\$2.30

ITEM #	DESCRIPTION	CATALOG #	\$
36	Wooden Clothes Pins - 24/pkg	83-2015-00	\$3.55
37	Modelling Clay - 12 colours	80-1271-00	\$1.90
38	Glass Marbles - 102/pkg	98-1160-00	\$1.60
39	3X Magnifier - 4"	B-14-229	\$2.20
40	6" Round Glass Mirror 3/pkg	B-14-289	\$3.40
41	6" Square Glass Mirror 3/pkg	B-14-290	\$3.40
42	6 LED Flashlight w/ Lanyard	B-14-5405	\$3.30

SEE WWW.KIDDER.CA FOR QUANTITY DISCOUNTS

Toll Free 1.800.263.3556 • Toll Free Fax 1.800.731.8424 • www.kidder.ca

Prices are subject to change without notice

Mini Hydraulic 4 in 1 Kit

This kits teach kids about simple machines and hydraulics. Using small syringes, the models move and work in a similar fashion that is seen in the big machines. Each kit can be built in an hour. They are high quality kits made of natural untreated wood. Builders only need scissors and a ruler. **Real wood, pegged together, makes for strong joints!**



CAT# 83-5404-04

Qty	Price
1	\$35.90
2-5	\$33.10
6-UP	\$28.95

STEM: Science & Engineering

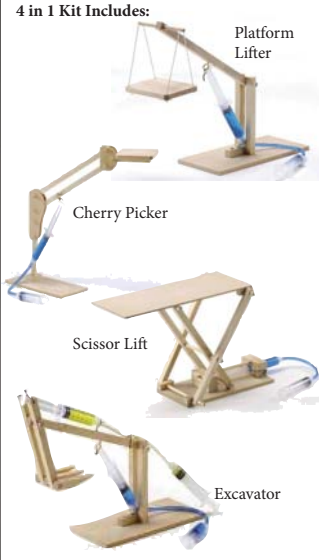

Deluxe Hydraulic Class Pack



This pack includes enough material to make at least 15 machines for 30 students and includes a teacher's information booklet with great lesson plans and ideas! All pages are photo copiable.

- Perfect for use in studies of:
- levers and simple machines
 - design and technology units
 - engineering and invention units
 - fluid studies
 - science fair activities
 - engineering Design Process units

Project Ideas

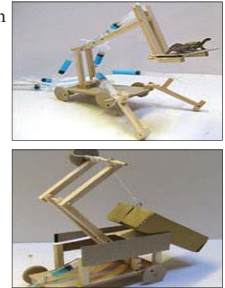

CAT# 83-50HYCP

Qty	Price
1	\$265.00
2+	\$238.00

Basswood Strips



100 Sticks / Bundle

These 24" bass wood strips are ideal for bridge design, hydraulic projects, house building and much more.

Cat#	Size	Price
83-BW066	6 x 6mm	\$46.20
83-BW088	8 x 8mm	\$49.70
83-BW1010	10 x 10mm	\$51.00
83-BW1212	12 x 12mm	\$58.00

Make Your Own Platforms (Plywood)



These baltic birch sheets can be cut in half to make project platforms. The sheets are 30" x 12" and 1/8" thick.

6/PKG

CAT# 83-BP504.....\$25.95 6 SHEETS/PKG

STEM Hydraulics Maker Set new

Our first reusable set of materials, this STEM Hydraulics Maker Set is a great resource for Science Centers, Museum programs, Maker Spaces and Tinkerer Labs. The Maker Set has 35 bases and enough material for 30 to 50 students to make a huge variety of machines from simple lifting machines to very complex robotic arms, allowing you to use the Set over a wide range of ages, from 6 to 60.

Great for family drop-in maker spaces, or for school and engineering outreach programs, this intuitive set is an easy way to deliver engineering, simple machines, bridges and many other curriculum outcomes to the science center and engineering outreach programs. It can be used with classes that last between 30 minutes to 2 hours, for groups that may include library spaces, Girl Guides or Scouts group programs.

Designed in collaboration with a cool Science Museum in California, this has been field tested and is now being used in Maker spaces. A great low-tech but open-ended program that will provide a deliverable program for many years!



CAT#83-54HYDST.....\$950.00

Toll Free 1.800.263.3556 • Toll Free Fax 1.800.731.8424 • www.kidder.ca

Prices are subject to change without notice

Syringes 5/pkg
(Luer Lock)



Size	Cat#	Pkg	2-5	6-19	20-49	50+
5cc	83-5004-00	\$2.45	\$2.20	\$1.94	\$1.84	\$1.70
10cc	83-5010-00	\$3.00	\$2.70	\$2.40	\$2.15	\$2.10
20cc	83-5020-00	\$3.90	\$3.50	\$3.10	\$2.80	\$2.75
30cc	83-5030-00	\$5.50	\$4.95	\$4.40	\$3.95	\$3.85
60cc	83-5060-00	\$9.95	\$9.00	\$8.00	\$7.20	-

Vinyl Tubing



CAT# 83-5005-00 25' tubing.....\$8.25
CAT# 83-5005-X4 30m/100 ft\$21.00
(fits all Leur loc syringes)

Project Idea

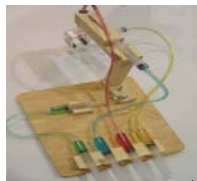

Valves & Connectors



2 way Stopcock



3 way Stopcock



Cat#	Description	1	2-5	6-19	20+
83-5015-00	2-way Stopcock 2/pkg	\$4.70	-	-	-
83-5014-00	3-Way Stopcock 2/pkg	\$5.10	\$	-	-
83-5011-00	Straight Connector 4/pkg	\$1.60	\$1.54	\$1.48	-
83-5013-00	T-Connector 4/pkg	\$3.05	\$2.75	\$2.45	-
83-5012-00	Elbow Connector 4/pkg	\$4.50	\$4.20	\$3.85	\$3.50

Pumping it Up with Pneumatics

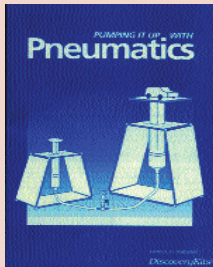

This booklet is designed to introduce you to basic pneumatic and hydraulic principals through design and make approach. The activities are suited for use by individual learners or within a Design Technology program.

CAT# 80-5756-00.....\$2.95

MOVE IT! - with Air or Water

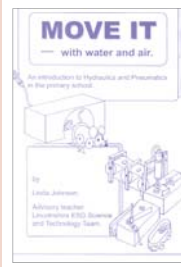

An introductory book design for primary and junior students. The ideas, hints and tips provide a resource for making movement using syringes and balloons.

CAT # 80-5700-11.....\$10.95

Self Adhesive Clips



6/pkg

These self-adhesive clips make project making easy. There are now two sizes available. They can also be used to mount batteries and toy motors.

CAT# 70-32-063 1" x 5/8"
\$5.60 6/pkg (for 10cc-30cc syringes and toy motors)

CAT# 70-32-043 1" x 3/8"
\$6.25 6/pkg (for 5cc syringes & "AA" batteries)

Hydraulics Class Pak



\$92.00

- Includes:
- 50 feet tubing#83-5005-00
 - 15 x 5 cc Syringe.....#83-5004-00
 - 15 x 10 cc Syringes#83-5010-00
 - 15 x 20 cc Syringes#83-5020-00
 - 15 x 30 cc Syringes#83-5030-00
 - 18 connectors & valves (assorted)
 - Hydraulics Workbook#80-5700-18

CAT# 83-5435-HY CLASS PAK

Robotic Arm

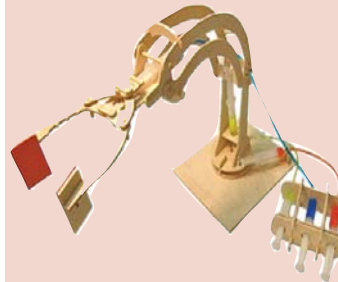

CAT# 83-50RBARM....\$24.45

See kidder.ca for quantity pricing

This robotic arm is an easy to make 3 dimensional model that grabs, lifts items horizontally, and can turn very close to 90 degrees! Designed to be used alone (with a nice syringe holder), or in a group - each person using one syringe. A great way to learn about Robotics, Levers and Simple Machines, Fluid dynamics, Engineering, and Invention, and Design and Technology

Hydrapult

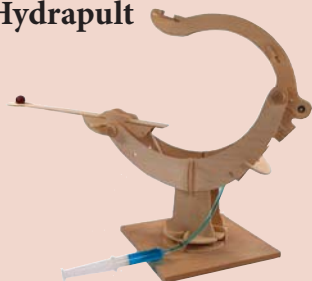

CAT# 83-50HDPLT.....\$25.30

KIDDER's Hydraulic Catapult uses the energy of moving fluid and levers to hurl items. Mixing science and art, this is a graceful 3 way hurling machine, that uses a double lever, a first class lever, and a third class lever to create different trajectories of clay balls (included). A great way to learn about levers and simple machines, how projectiles fly, and to test theories about release angles, weight of projectiles and even teach kids to learn to graph with a fun and engaging activity!

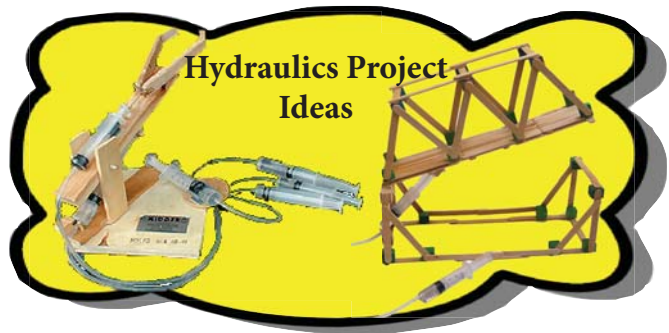

Hydraulics Project Ideas

Unit#3-39 Glen Cameron Road, Thornhill, ON, L3T 1P1

Prices are subject to change without notice



Head to www.kidder.ca for more pictures and details on each of these kits and more from TeacherGeek!

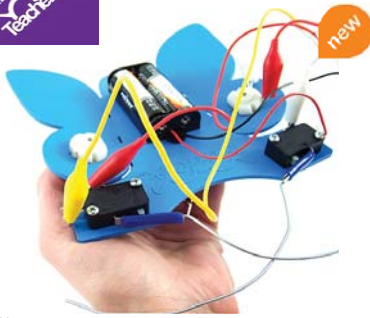

“Catch The Bug”

Are you ready to “Catch the Bug”? The bug is a truly fantastic and meaningful electronics learning activity. Finished bugs run around the floor with their own personality. They roam and explore by bumping into objects and finding new paths around the room.

CAT# 9T-182287.....\$132.00 10/PKG

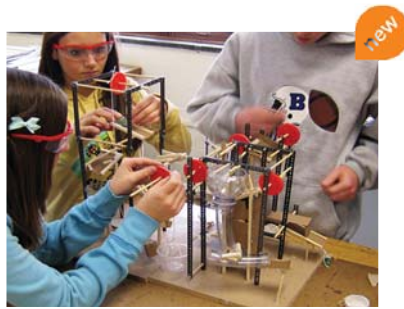

Crazy Contraptions

“Crazy Contraptions” is a thought provoking activity that engages students in the design and construction of exciting and innovative Rube Goldberg style mechanisms. Each Crazy Contraption requires a 12”x12” wood base with drilled holes. Available online at www.kidder.ca along with kit components list.

CAT# 9T-182289.....\$371.00



Ping-Pong Ball Launcher

A good projectile launcher is able to shoot with precision (the ability to hit the same spot, over and over) and accuracy (how close you get to the target). It should be able to change one variable at a time, utilizing scientific and engineering methods to hit the target. This activity allows you to create a launcher that does all of these things, and more.

CAT# 9T-182305.....\$121.50 10/PKG



Advanced Hydraulic Arm

The arm is built totally by you, from scratch! You construct it by measuring, cutting,reaming holes and tapping. This arm is “advanced,” because it has 8 cylinders (4 cylinders move the arm, 4 cylinders form the control panel), and it has parts to make it into almost anything you can imagine. Build it using the instructions, then re-engineer it! Create your own unique design, incorporating recycled materials or anything else you can find. It comes with plenty of extra components included to help you change and create something completely new.

CAT# 9T-182309.....\$383.00 10/PKG



Mini Wind Turbine

Build a working mini wind turbine that is truly your design. Learn through inquiry and experimentation. Found (recycling bin) materials are used to create the blades, and sometimes other parts of the turbine. Attach the blades to toothpicks (included) and mount them to the turbine hub. The hub holds 1 to 6 turbine blades, and allows you to adjust their angles. Learn how the shape, number and angle of turbine blades effects electrical output of your wind turbine. You will have plenty of extra parts to try different designs.

CAT# 9T-182313.....\$71.50 10/PKG



Wiggle-Bots - Super Pack

Wiggle-Bots are much more than “a lot of fun”. They inspire. Watch eyes widen as wires are connected and Wiggle-Bots start to move. See how understanding and design evolves through experimentation (tinkering). Appreciate the challenge of going beyond step by step instructions and creating something completely new (innovating). It’s an incredible experience. How will you Wiggle? Your Wiggle-Bot can be designed to do many cool things.

CAT# 9T-182456.....\$130.50 10/PKG



Wiggle-Bots - Regular Pack

Wiggle-Bot components and resources are all specifically design to facilitate innovation. Wiggle-Bot’s use TeacherGeek™ components, which allow kids to easily experiment, change their designs, and integrate other materials (recycling bin or other materials you have available). When kids innovate, they engage like never before. They take pride and ownership. Solving the challenge brings them a tremendous feeling of success and accomplishment. Wiggle-Bots do not get old, like many other activities, because designs can always be modified and improved. Kids/students learn far more from their design revisions, than they do from their original design.

CAT# 9T-182457.....\$95.50 10/PKG

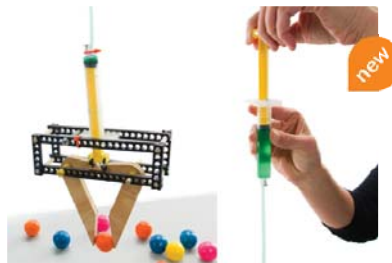

Hydraulic Claw

Design and build a hydraulic claw that works like the ones in the arcade. Move the upper cylinder and watch your claw open and close below. We have documents to get you started, but the final claw design up to you. Can you design a claw to pick up specific objects (worms, marshmallows, balls)? Take a look at kidder.ca for ideas and inspirations. Make your claw even better by incorporating recycling bin material.

CAT# 9T-182460.....\$104.50 10/PKG



Advanced Rubber Racer

Design and engineer a vehicle that is propelled by the energy stored in rubber bands. Make it go for distance, or stop with precision. Design it to go fast, or cross a difficult terrain. Rubber band racers can be easily redesigned/reconfigured, so every day you can have a different challenge. Learn by experiencing potential and kinetic energy, simple machines, friction, elasticity and ratios. Learn how friction can help, and hurt your racer. This activity is one of our most popular.

CAT# 9T-182296.....\$159.50 10/PKG



Large Mixed Gears

The 40 Pack contains 10 of the following sizes: 10 tooth, 20 tooth, 40 tooth, 50 tooth

CAT# 9T-182328.....\$23.80 40/PKG



Hole Plates 20pc Pack

Every project needs a frame; something to hold it together, or support it. That's where hole plates are really, really handy. Their corner holes are splined, so dowels press into them and stay stuck. The remaining 196 holes are larger than a dowel, allowing dowels to spin and slide. We use hole plates on vehicles, launchers, wind turbines, hydraulic arms and loads of other projects.

CAT# 9T-182332.....\$16.55 20/PKG



Perpendicular Blocks

Perpendicular blocks are extremely useful. If you are planning on building anything, you should have a pile of them ready. How do they work? It's simple; they hold dowels at a right (90 degree) angle. Perpendicular blocks come with holes that dowels press and stay stuck into. These holes can be reamed; allowing dowels to slide and spin.

CAT# 9T-182334.....\$20.90 100/PKG



Reamer

The reamer is an essential tool when building with TeacherGeek components. It changes the holes in components from a press fit (where the dowel stays stuck) to a loose fit (where the dowels spin and slide).

CAT# 9T-182387.....\$8.70

Component Pieces



Large Mixed Pulleys

This 40 Pack contains 10 of the following sizes: 70mm, 55.5mm, 25.5mm, 9mm

CAT# 9T-182329.....\$25.20 40/PKG



Connector Strips 12"

TeacherGeek 300mm Connector Strips are basic structural components to build bridges, vehicle chassis, hydraulic arms, crazy contraptions, launchers, structures or original design innovations. The splined holes securely hold dowels or can be reamed for axle rotation. These strips are easily cut to your desired size. 12" long

CAT# 9T-182331.....\$26.60 50/PKG



Maker Tool Set

What are the essential tools that you will need to make just about anything out of TeacherGeek parts? Here they are...TeacherGeek Multi-Cutters, A TeacherGeek Reamer, Pliers, A Screwdriver. Tools can be ordered individually - see www.kidder.ca.

CAT# 9T-182384.....\$52.00 4PC



5mm Dowel

These high quality 5mm birch dowels are used in every activity, every project, every invention. If you are planning on making anything, we highly recommend that you put some in your shopping cart.

CAT# 9T-182335.....\$25.85 50/PKG



Wheel & Hub Set

Why do we call them "wheel-hubs"? Simple. It's because they can be wheels for vehicles, or a hub for wind turbine rotor. Their splined holes allow dowels to press securely into them, so the dowels and wheel-hubs turn together.

CAT# 9T-182330.....\$34.95 40/PKG



Angle Bracket

TeacherGeek Angle Brackets are used to make 3 dimensional frames. They join connector-strips at various angles (15, 30, 45, 60 or 90 degrees). Dowels fit securely into their splined corner holes.

CAT# 9T-182333.....\$18.80 60/PKG

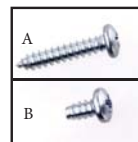

A. Self Tap Screws

#10X3/8" Self Tap Screws for bugs.

CAT# 9T-182391...\$4.35 100/PKG

B. Self Tap Pan Screws

#10X3/4" Self Tap Pan Screws for bugs.

CAT# 9T-182365...\$4.60 100/PKG



Hex Nut

Tighten these nuts onto #10 machine screws to keep your projects held together.

CAT# 9T-182325 \$2.80 100/PKG



1" Machine Screws

#10 x 1" Screws, MOST POPULAR! It's long enough to fasten most TeacherGeek and recycling bin components together.

CAT# 9T-182322..\$5.60 100/PKG



1 1/2" Machine Screws

#10 x 1 1/2" Screws, We use them for projectile launchers, and other special applications.

CAT# 9T-182323..\$7.70 100/PKG



#10 Washer

Reduce the friction between two components on a dowel, or keep a bolt from pulling through your parts with this washer.

CAT# 9T-182324..\$3.00 100/PKG



#10-24 Nylon Lock Nut

The nylon inserts within these nuts provide resistance to keep them from coming loose on machine screws.

CAT# 9T-182326..\$7.20 100/PKG

These prepackaged programs are the perfect way to start a model rocketry program. You will need a classroom and an open area about 1/2 the size of a football field to run 4-6 one hour building, flying and learning sessions for a one to two week program.

Alpha Rocket™ new
12 Rockets Bulk Pack

Cat#99-ES471..\$146.00

Skill Level 1

Length: 12.3 in. (31.1 cm)
 Diameter: .98 in. (25 mm),
 Estimated Weight: .8 oz. (23 g)

Laser cut Wood fins, Self-stick
 Decals, Parachute Recovery

Recommended Engines:
 1/2A6-2, A8-3 (First Flight),
 A8-5, B4-4, B6-4, B6-6, C6-5,
 C6-7
 Projected Max Altitude: 1000
 ft. (305 m)

12 Rockets per Bulk Pack



Wizard Rocket™ new
12 Rockets Bulk Pack

Cat#99-ES477 ..\$93.00

Skill Level 1

Length: 12 in. (30.5 cm)
 Diameter: .74 in. (19 mm)
 Estimated Weight: .5 oz. (14.2 g)

Laser cut Wood Fins, Self-stick
 Decals, Streamer Recovery

Recommended Engines: 1/2A6-2,
 A8-3 (First Flight), A8-5, B4-4,
 B6-4, B6-6, C6-5, C6-7

Projected Max Altitude: 1600 ft.
 (488 m)

12 Rockets per Bulk Pack



Comet Chaser™ new
12 Rockets Bulk Pack

Cat# 99-ES473 ..\$134.00

Skill Level 1 - Beginner builder
 skills

Length: 14.4 in. (36.5 cm)
 Diameter: .98 in. (25 mm)
 Estimated Weight: 1.3 oz. (36.8 g)

Laser Cut Wood Fins, Waterslide
 Decals, 12 in. (30.5 cm) Parachute

Recommended Engines: A6-4
 (First Flight), B6-4, C6-5,

Projected Max Altitude: 1150 ft.
 (351 m)

12 Rockets per Bulk Pack



Loadstar II™ new
12 Rockets Bulk Pack

Cat# 99-ES475 ..\$195.00

Skill Level 2 - Average building
 skills.

Length: 23.3 in. (59.2 cm)
 Diameter: 1.64 in. (42 mm)
 Estimated Weight (without pay-
 load): 2.8 oz. (80.1 g)

Laser cut Wood Fins, Clear
 Payload Section, 18 in. (46 cm)
 Parachute Recovery

Recommended Engines: Single
 B6-4, C6-5

Projected Max Altitude: 1000 ft.
 (305 m)

12 Rockets per Bulk Pack



Model Rocketry Supplies

Rocket Motors

E. F. G. H. I.



A8-3 B6-4 C6-3 C6-5 C6-0

Each package includes 3 motors and igniter.

J. 25 Rocket Motor Value Pack

Includes motors, igniters, wadding

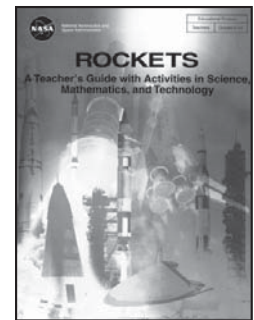

Cat# 80-5746-00....\$19.90
 (See more details on pg 48)

L. Recovery Wadding



K. Igniters



O. Altitude Finder



N. Controller



P. Fin Alignment Guide



Q. Altimeter



M. Launch Pad



Fig	Cat#	Description	1	2-5	6-19
A	99-E1756	Alpha Rocket (individual kit)	\$15.70	\$13.95	
B	99-E1754	Wizard Rocket (individual kit)	\$10.00	\$8.90	
C	99-E1722	Comet Chaser (individual kit)	\$14.40	\$12.80	
D	99-E1760	Loadstar II (individual kit)	\$20.95	\$18.60	
E	99-E6914	A8-3 Rocket Motors w/Igniters 3Pk	\$13.20	\$11.60	
F	99-E6917	B6-4 Rocket Motors w/Igniters 3Pk	\$13.40	\$11.80	
G	99-E6923	C6-3 Rocket Motors w/Igniters 3Pk	\$17.30	\$15.25	
H	99-E6925	C6-5 Rocket Motors w/Igniters 3Pk	\$15.65	\$13.80	
I	99-E6937	C6-0 Rocket Motors w/Igniters 3Pk	\$17.30	\$15.25	
J	99-E546914	A8-3 24 PCS Value Pack	\$88.00	-	-
J	99-E546917	B6-4 24 PCS Value Pack	\$89.00	-	-
J	99-E546923	C6-3 24 PCS Value Pack	\$115.00	-	-
K	99-E2302	Extra Tiger Tail II Igniters 6/pkg	\$8.60	\$7.65	\$6.70
L	99-E7120	Recovery Wadding 72 shts	\$7.65		
M	99-E7610	Launch Pad	\$23.70		
N	99-E7510	Electronic Controller	\$27.90	\$24.40	
O	99-E2232	Altitude Tracker	\$26.85		
P	99-E2231	Fin Alignment Guide	\$30.70	\$26.85	
Q	99-E2246	Altimeter	\$54.50		

Toll Free 1.800.263.3556 • Toll Free Fax 1.800.731.8424 • www.kidder.ca

Prices are subject to change without notice

Delta Dart



This model is best suited for first time builders. It can be built using glue sticks in conjunction with white glue for faster, easier and cleaner projects.

Class Pack 35 Kits
CAT# 19-FF-510.....\$67.50
 To make 35 Delta Darts

Individual Kits
CAT# 19-FF510KT.....\$2.90

Right Flyer

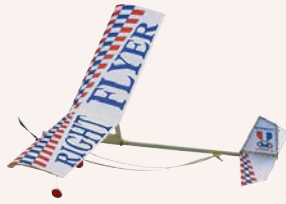

This model has cambered airfoil wings and a low thrustline for high endurance flights. It can be flown with or without landing gear for drag/weight experiments.

Class Pack 24 Kits
CAT# 19-FF-501.....\$128.50
 To make 24 Right Flyers

Individual Kits
CAT# 19-FF501KT..... \$8.55

Glider



This glider is incredibly fun to fly, and easy to build. No glue is required, and assembly takes just minutes. Wind the rubber band powered propeller and watch it float through the air! Landing gear provides safe landing so you can enjoy flight after flight!

Single Kits ▶▶
CAT# 99-E3430

Qty	Price
1	\$4.95
2-5	\$4.55
6-19	\$4.05

24 Student Class Pack
CAT# 99-E543430..\$88.00

Helicopter



This rubberband powered Helicopter is simple to construct and amazing to watch fly. Wind the rubbermotor, let go, and this helicopter will soar up to the sky!

Single Kits ▶▶
CAT# 99-9621

Qty	Price
1-1	\$5.15
2-5	\$4.55
6-19	\$4.20
20-49	\$3.90
50-up	\$3.65

20 Student Class Pack
CAT# 99-54-9621..\$76.00

Build Your Own Model Plane!



Propeller is 152 mm and includes plastic nose and bearing shaft. (used with drive bands below)

CAT# 19-FF-380\$18.50 35/PKG



3" plastic 3 blade propeller. (for 2mm shaft motor)

CAT# 80-3555-00.....\$7.90 6/PKG

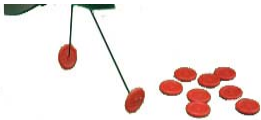

Model plane wheels, 3/4" in diameter.

CAT# 19-FF-931\$22.10 100/PKG



An airplane propeller with 2mm shaft. 150mm long.

CAT# 80-3556-00.....\$13.30 10/PKG



This package contains 3 propellers. Each propeller is made from hi-impact plastic and can be used for a variety of hobby needs. They are 4" in length and have a 1mm diameter hole.

CAT# 80-3556-40.....\$4.40 3/PKG



3-9Volt Toy Motors (with 2mm shaft) Ideal for use with props 80-3556-00 & 80-3555-00.

CAT# 80-3550-00.....\$8.90 6/PKG



Use these bands with the propeller assembly to drive plane or other kits. The strands can be tied to make a loop.

CAT# 19-FF-370 \$9.90 35/PKG

Balloon Helicopter Kit



Effectively demonstrates Newton's Third Law with this exciting and simple product. Balloon Helicopter kit contains: 1 balloon, 3 rotor blades, 1 mouth piece, 1 blade assembly. Air pump included. 12 kits/pkg

CAT# 99-7030-03.....\$18.25 12/PKG



This rubber motor drive for propellers is 1/8" x 48ft. It is made of high quality rubber and can withstand 1000 winds. 1/8" x 48"

CAT# 19-FF-378 \$13.50

Balsa Wood Scrap Pack



Balsa is a very light wood excellent for model plane building.

Package contains various strips & sheets.

CAT# 83-AWPKG

Qty	\$/Pkg
1	\$7.20
2-5	\$6.65
6-19	\$6.50
20+	\$6.30

Balsa Wood Sheets



6 Sheets per bundle!

Use these balsa sheets to design your own wings! Balsa is the ideal wood for model planes as it is light, durable and easy to cut. Four different size options below. Be sure to check out our cutting tools on page..

Cat#	Size	Wood	Price	2-5	6+
83-AW402	4" x 18" x 1/16"	Balsa Sheets	\$11.50	\$10.20	-
83-AW403	4" x 18" x 3/32"	Balsa Sheets	\$12.70	\$11.30	\$10.15
83-AW404	4" x 18" x 1/8"	Balsa Sheets	\$13.25	\$11.75	\$10.60
83-AW406	4" X 18" X 3/8"	Balsa Sheets	\$16.20	\$14.60	\$13.35

5 to 1 Winder

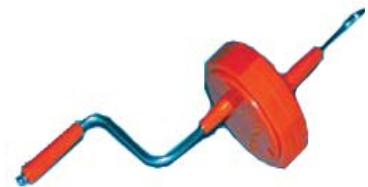

Use this tool to quickly wind rubber motors on our airplanes and boats. This labor saving tool winds 5 revolutions on the motor for every 1 hand crank turn.

CAT# 19-40-389.....\$9.75

Pressure Pop Bottle Rocket Launcher

This launcher fires normal 2 litre PET bottles up to 40 m. Students can decorate their bottles to get optimum performance. An air pressure source and pop bottle is required. Stopper and valve included.

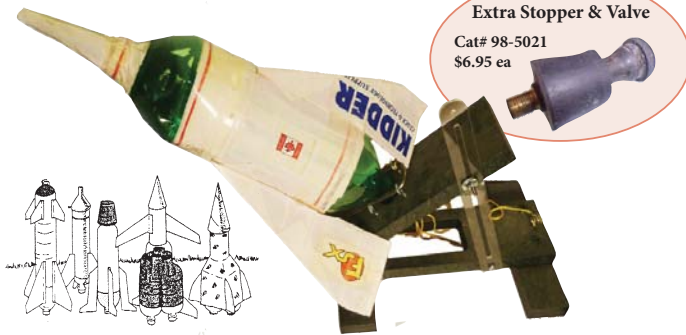

CAT# 98-5001-00.....\$64.50

T-Bolt™ Air Rocket Party Pack

new



Let's get the party started! Simply twist together the air tubes, stand back and have FUN! The T-Bolt Party packs comes with one launch system and 6 air rockets! Challenge your friends. See who can get their rocket to go the highest! Air rockets requires no assembly and are a "blast" to launch! High-Volume launch pump and sturdy launch pad included and are made from very durable high grade plastic.

CAT# 99-E1700.....\$105.00 (2+ \$90.50)

Straw Rockets - Getting Started Package



CAT# 99-SR35783
\$369.00

Building and experimenting with these simple rockets is the perfect way to introduce students to rocketry. And they'll learn a bevy of physics principles in the process! Enough materials for 30 students to build four rockets each. The Straw Rocket Launcher and the Straw Rocket video are included. Requires scissors, ruler, and transparent tape, not included.

Teacher's Guide

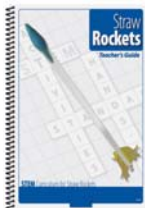

Straw rockets might be an introductory rocket activity, but this guide will help you get a lot of educational mileage out of them! With these fun activities, students grasp a variety of subjects including force and motion, thrust, center of gravity, prediction, measurements, and tons more. The Straw Rockets contains teacher and student instructions for a variety of math, science, and technology activities; pretests and posttests; resource pages; and puzzles.

Teacher's Guide contains teacher and student instructions for a variety of math, science, and technology activities; pretests and posttests; resource pages; and puzzles.

CAT# 99-SR59459.....\$47.65

Straw Rocket Launcher



Students can build their own straw rockets and test them on the Straw Rocket Launcher. Just like early rocket pioneer Robert Goddard, they can conduct scientific experiments by varying the trajectory angle and launch energy. These rockets can travel up to 50 feet! The Straw Rocket Launcher uses pneumatic force created by releasing a weighted drop rod in the cylinder to launch rockets. The force of the launch can be controlled by varying the release height of the rod. The launcher features: Simple operation Adjustable trajectory angle with angle gauge

CAT# 99-SR20426.....\$318.00

Straw Rocket DVD



Whether you want to show students how to design and launch rockets or see how to maintain the Straw Rocket Launcher, this video covers it all!

Includes:
- Rocket design and construction with reminders to consider variables such as rocket length, fin shape, and nose cone size

- Launching your rocket
- Maintaining the launcher
- Activity testing the trajectory angle's effect on the rocket's flight
- Newton's laws of motion and how they apply to the activity
- STEM concepts used in the activity

CAT# 99-SR59993.....\$47.65

Straw Rocket Class Pack



For a fun and easy activity to illustrate oodles of scientific principles, look no further than this introductory rocket project. The Straw Rocket Class Pack will help teach projectile motion, center of gravity, initial velocity, introductory aerodynamics, and more. This activity is a great way to teach students the principles of rocketry before going on to engine- or hydrogen-powered rockets. This pack includes enough Precision Straws, clay, and fin material for 30 students to make four rockets each, which enables them to experiment with different weights, straw lengths, and fin designs. Pack includes student instructions. Requires launcher, scissors, ruler, and transparent tape, sold separately.

CAT# 99-SR35784.....\$43.95

Precision Straws - Variety Pack



Manufactured to fit perfectly on the Straw Rocket Launcher, Precision Straws are used to make straw rockets that will launch every time! They are made from Mylar for durability and can also be glued. 120/pkg

CAT# 99-SR35781
\$34.90 120/PKG



new

EQ Refractor Telescope

The refractor telescope uses a lens to gather and focus light. Comes with right angle eyepiece adapter, finder scope (5x 24”), sunshade, aluminum tripod, lunar and sun filters and accessory tray.

Features:

- Lens diameter: 60mm, 2”
- Focal length: 900mm
- Eyepieces: 10mm, 25mm, 2x Barlow lens
- Maximum Magnification: 140x (10mm eyepiece with 2x Barlow lens)

CAT# B-14-525.....\$315.00



new

EQ Reflector Telescope

The reflector telescope uses a curved mirror to gather and focus light. This telescope has an aperture of 114mm (4½”) and a focal length of 900mm. 3 Plossol eyepieces are included (6.5mm, 10mm, 25mm), as well as a 2x Barlow lens. Total magnification is 277x with the 2x Barlow lens. Also comes with accessory tray and 2 year warranty.

Accessories:

- Plossol 6.5mm AF 50° eyepieces
- Plossol 10mm AF 43° eyepieces
- Plossol 25mm AF 40° eyepieces
- Equatorial mount with cable controls
- Equatorial mount with cable controls
- Moon and sun filters
- Camera adapter to be used with 35mm CSR

CAT# B-14-527.....\$419.00



new

EQ Short Tube Reflector

This reflector telescope has an aperture of 114mm (4½”) and a focal length of 1000mm. It comes with 3 Plossol eyepieces-6.5mm, 10mm, 25mm, for a magnification of 40x, 100x and 154x. Camera adapter to be used with 35mm CSR. 2 year warranty.

Accessories:

- Plossol 6.5mm AF 50° eyepieces
- Plossol 10mm AF 43° eyepieces
- Plossol 25mm AF 40° eyepieces
- 6x x 30mm finder scope
- Equatorial mount with flexible cable controls
- Aluminum tripod
- Moon and sun filters
- Accessory tray

CAT# B-14-526.....\$456.00



new

Inflatable Solar System

Every Science Classroom should have all 8 planets including Pluto and the Sun hanging from the ceiling! These are very easy to display , durable, washable, easy to store, includes Foot pump, eight planets + pluto & sun and an activity guide is included!

CAT# B-14-615.....\$72.50



new

A.



new

B.

Solar System Kit

Construct your own solar system diagram! This pack contains nine planets and one sun. Directions for assembly and fun facts are printed on the box. Available in Painted or non-painted.

A. CAT# B-14-622 (PAINTED).....\$16.25
 B. CAT# B-14-621 (NON-PAINTED) \$9.95



new

Mega Volcano Kit

Our New Mega Volcano Kit is quick, easy, and LARGE, almost 11” tall and wide! The plaster versions are messy, time consuming, and disappointingly small, and Paper Mache has its own challenges. Our Volcano is pre-molded into three pieces that go together in seconds. Build, Paint, Erupt. Three easy steps! It can even go back in the box. All you need is some basic household items for unlimited eruptions. Vinegar, baking soda, red food coloring and liquid dish soap are not included. Kit includes Paint and brushes.

CAT# B-14K103.....\$29.65

MudWatt Core Kit



new

- Core Kit Includes:
- 1 x MudWatt ANODE
 - 1 x MudWatt CATHODE
 - 1 x MudWatt BLINKER BOARD
 - 1 x Educational/Instruction Booklet
 - 1 x Pair of Black Nitrile Gloves
 - Free MudWatt Explorer App (available on iTunes and Google Play)
 - *Mason Jar not included*

CAT# 80-MW10011.....\$47.25

KIDDER

DESIGN TECHNOLOGY & SCIENCE EDUCATION

The MudWatt is a fun and educational science kit that uses the natural micro-organisms found within dirt to generate electricity! Within a few days, the MudWatt's LED light will start to blink using the power generated by bacteria within your dirt. Within a week, you'll be able to power a digital clock and thermometer - no batteries needed!

Enjoy discovery with one of the most creative, interdisciplinary STEM educational toys for the modern world: microbiology, chemistry, and electrical engineering all in one kit! Head to kidder.ca for videos, diagrams and more MudWatt product options!

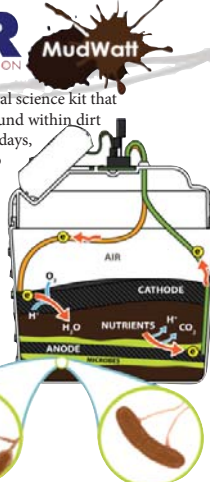

MudWatt Classroom Set



new

- Classroom Pack Includes:
- 10 x MudWatt CORE KITS
 - 10 x MudWatt VESSELS
 - 3 x MudWatt Digital Clocks
 - 3 x MudWatt MAXTRACKERS (Multimeter and Resistor sets)
 - 18 x Alligator Clips (for connecting MudWatts together)
 - MudWatt Explorer App (available on iTunes and Google Play)
 - Free access to the MudWatt NGSS Teacher's Guide and other Educational Resources

CAT# 80-MW10051.....\$473.00

KIDDER SCOPE

new

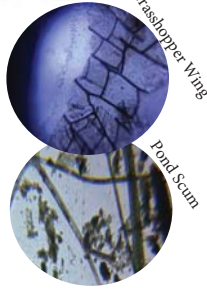

- Turns your SmartPhone into a Microscope!
- Totally portable, visible to other students
- Capable of enlarging Rocks & Minerals as well as Microscopic Specimens
- Photo & Video Capabilities to Post & Share
- SmartPhone not included

Includes all hardware, LED Light Source; Acrylic Panels all pre-drilled with heavy duty base. Easy height adjustment wing nuts with special lens insert & easy to assemble instructions! Images above taken with a Kidder Scope.

CAT# B-14-5400.....\$34.95 (6-19 \$32.00 20+ \$25.60)

Mirror Strips to Build a Kaleidoscope

Use these mirrors along with some sequins to make a kaleidoscope. The strips are 11 3/4" x 2".



Cardboard tube not provided.



Qty	\$/ea
1	\$2.45
2-5	\$2.30
6+	\$2.15

CAT# B-14-298

Form mirrors into a triangle. Use three mirror strips for best results.

Periscope Kit



Build your own periscope. Allows the user to construct a simple periscope to raise the eye-level by approximately 25cm. Enough parts are included to make 10 periscopes. CAT# B-14-310.....\$23.50 10/PKG



UV Beads

These UV beads are extremely sensitive to natural light and change colour dramatically from white to various colours when exposed to sunlight or- even on an overcast day. Containing trace amounts of a photochromic pigment that are sensitive to the ultraviolet component of daylight, the beads have many different uses ranging from scientific testing of (UV) sun block materials to the creation of 'smart' jewellery. Available as pack 1000 beads per bag of assorted colours.

CAT# B-14UVBDS.....\$9.00 250/PKG

76mm Mirror Squares

1/8" thick 3mm mirror squares great for optics projects.

Qty	\$/ea
1	\$1.95
2-5	\$1.68
6-19	\$1.40
20-49	\$1.15
50-up	\$0.85



CAT# B-14-295

Amazing Illusions Kit



- Have fun with fantastic optical illusions.
- The kit includes a magical mirascope that produces true to life floating images; try to touch them, it's impossible! Great fun for all the family.
- Make a kaleidoscope and a pin hole camera.
- Create exciting illusions with your own eyes.
- Distorting mirrors, jumping fish and many more great activities.

CAT# B-14-200.....\$33.95

Ray Box With Optional Beam Slots



This Ray Box is powerful enough to allow the visualization of light rays under normal ambient lighting conditions. Model B-14-SL20 can emit a wide light beam or 1, 3 or 5 narrow rays depending upon which magnetized card is placed on the front panel of the unit (4 cards are included). Model B-14-SL20 allows for the study of the convergence and divergence of light through the use of a series of magnetized cards. (See www.kidder.ca for more details.)

CAT# B-14-SL20..... \$238.00

Glass Erlenmeyer Flasks

For quantity discounts see www.kidder.ca



50 ml	CAT# 83-72-0050	\$3.15
100 ml	CAT# 83-72-0100	\$5.75
250 ml	CAT# 83-72-0250	\$6.75
500 ml	CAT# 83-72-0500	\$8.80
1000 ml	CAT# 83-72-1000	\$14.65

Borosilicate Glass Beakers

For quantity discounts see www.kidder.ca



50 ml	CAT# 83-7062-00	\$3.15
100 ml	CAT# 83-7063-00	\$3.30
250 ml	CAT# 83-7065-00	\$4.50
400 ml	CAT# 83-7066-00	\$5.05
500 ml	CAT# 83-7067-00	\$5.65
600 ml	CAT# 83-7068-00	\$6.20
1 l	CAT# 83-7069-00	\$7.90
2 l	CAT# 83-7070-00	\$15.75

Glass Graduated Cylinders

For quantity discounts see www.kidder.ca



10 ml	CAT# 83-8121-00	\$4.20
25 ml	CAT# 83-8122-00	\$5.20
50 ml	CAT# 83-8123-00	\$7.50
100 ml	CAT# 83-8124-00	\$10.15
250 ml	CAT# 83-8125-00	\$16.90
500 ml	CAT# 83-8126-00	\$26.25
1000 ml	CAT# 83-8127-00	\$50.00

Glass Volumetric Flasks

Comes with lid enclosure!

new



100 mL	CAT# 83-71-0100	\$5.00
250 mL	CAT# 83-71-0250	\$6.50
500 mL	CAT# 83-71-0500	\$8.80
1000 mL	CAT# 83-71-1000	\$12.00

Plastic Beakers



- Set includes 50,100,250,500, and 1000 ml beakers
- Durable polypropylene construction with printed numerical graduations on the outside.
- Resistant to most common acids, bases and solvents. Wide base for stability.
- Pouring spouts.
- Autoclavable to 130°C (250°F).
- Nestable.

CAT# 83-8050-06.....\$22.50 5/SET

Thermometers

Red Alcohol



Qty	\$ ea
1	\$2.70
2+	\$2.40

- 20-100C - CAT# 83-7012-00
- 20-110C - CAT# 83-7016-00
- 20-150C - CAT# 83-7044-00

Transfer Pipette - 20/pkg



TRANSFER PIPETTE, PP.1.7 ML
CAP - 3" length

CAT# 83-5097-00.\$4.50 20/PKG

Glass Test Tubes



10/pkg

These glass test tubes are 18mm x 150mm. #1 Stoppers are compatible with this tube.

CAT# 83-8065-00 \$15.00

Plastic Test Tubes



12/pkg

Provided as a set of 12 tubes of size 17 X 100 MM with closures

CAT# 83-8061-00 \$10.80

Test Tube Rack

new



- Replacement for wood and metal racks.
- Has six openings of 18 and 25mm diameter on top plate, with hemispherical wells and drying pins.
- Open side for clear viewing.
- Can be easily assembled.
- Dimensions: (L x W x H) 240 x 70 x 90mm.

CAT# 83-8082-00..... \$5.30

Test Tube Clamp

- Made of nickel plated spring steel wire.
- Has self-closing jaws with finger grips.
- About 16cm long.



CAT# 83-8085-00.....\$1.75

Beaker Tongs

- Holds beakers from 50mL upto 2000mL capacity.
- Made of plated steel.
- Jaws are plasticated.
- 25 cm L, 17 cm jaw opening



CAT# 83-8091-00.....\$6.10

Beaker Brush - LG

new



Large brush with radial, double-fan tip and full black nylon bristles makes complete contact with cylinder walls and bottom.

Galvanized wire handle that resists rust and corrosion.

2 3/8" Dia x 6"L, Overall Length 20"

CAT# 83-8073-00..... \$2.80

Beaker Brush - SM

new



Smaller brush with radial, double-fan tip and full black nylon bristles makes complete contact with cylinder walls and bottom. Medium and small brushes with radial tufted nylon end. Galvanized wire handle that resists rust and corrosion.

1/4" Dia x 3.5"L, Overall Length 9.5"

CAT# 83-8071-00..... \$2.80

Rubber Stoppers

new



They are sold by the pound. Ideal for Test Tubes, Flasks and Cylinders.

#1 Stopper - CAT# 80-4288-01	1lbs	\$18.50
#4 Stopper - CAT# 80-4288-04	1lbs	\$18.50
#5 Stopper - CAT# 80-4288-05	1lbs	\$18.50
#6 Stopper - CAT# 80-4288-06	1lbs	\$18.50

Support Stand

new

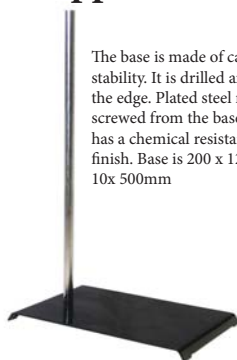

The base is made of cast iron for stability. It is drilled and tapped on the edge. Plated steel rod can be unscrewed from the base for storage. It has a chemical resistant, baked enamel finish. Base is 200 x 125mm. Rod is 10x 500mm

CAT# 83-1157-CI..... \$21.25
(6+ \$17.00)

Burette Clamp

new



The plastic coated jaws may be locked by a steel thumbscrew. It is constructed of stamped steel and zinc-plated. The jaw opens from 10-35mm. The overall length is 162mm. Compatible with Support Stand (Cat#83-1157-CI)

CAT# 83-1157-BC.....\$13.50
(6+ \$10.80)

Portable Micro Burner

new



This portable burner does not have wicks to replace or gas lines to install! Stable, tip resistant design with easy grip handle, provides safe use and portability anywhere in the lab or work area. Just open the butane valve and push the ignition button for an adjustable, clean-burning flame. The Micro Burner is refillable from a standard butane cartridge. 3-1/2" (90mm) tall by 5" (125mm) long. 40g fuel capacity. 1-2 hours use per fill.

CAT# 83-72-0009.....\$68.50
(2+ \$65.00)

Basic Student Microscope



CAT# B-1443504

\$157.50 (2+ \$149.50)

Economy microscope in all metal body 40 to 400x magnification, 360° rotatable monocular head and 45° inclined. Triple nose piece with positive click stops. Supplied in styrofoam case w/ vinyl dustcover. Eyepiece: 10x W.F. with pointer Objective: 4x, 10x and 40x (retractable) achromatic Diaphragm: 6 hole disc with fixed condenser 0.65 N.A. Stage: 90 x 90 mm with spring mounted clips with adjustable stage stop. Illuminator: Built-in incandescent lamp 15W with on/off switch Focusing: Coarse control

Advanced Student Microscope



CAT# B-14BI384

\$280.00 (2+ \$252.00)

- Eyepiece: W.F.10x w/ rotating pointer
- Objective: achromatic 4x, 10x, 40x
- Mechanical stage (optional)
- Magnification: 40x to 400x
- Illuminator: Built-in incandescent lamp 6V/15W with on/off switch
- Disc diaphragm
- Fine (F)/Coarse (C) control
- Supplied in styrofoam case w/ vinyl dustcover

Petri Dishes

new



- 100 x 15mm
- Plastic Sterile Dishes
- Variety of options below.
- Comes with lid enclosure

Cat#	Description	6-19	20-49
B-14-415	25/pkg	\$21.50	\$19.50
B-14-416	100/pkg	\$87.50	-
B-14-417	25/pkg w/ Agar	\$42.00	-

Slide Making Kit

new



- Get started in the fascinating study of the microscopic world
- Make your own microscope slides
- Learn how to view them
- Complete kit with clearly written instructions
- Hatch your own brine shrimp for microscopic study

CAT# B-14-245.....\$21.00

Chemistry 60 Kit

new



This Chem 60 set includes 60 safe and fun activities; helping your child learn and play at the same time. There is no fear of working with dangerous chemicals or poisons. The topics covered in the kit deal with chemical reactions; acids and bases; chromatography; grow crystal; surface tension; solutions and colloids; expansion of gases; magnetism; optics; cultivating plants and more. Simple experiments are performed using the contents of the kit and common household items. *See kidder.ca for materials list.

CAT# 80-54-6013.....\$47.85

Dual Hand Lens

CAT# B-14-223



\$12.25 10/pkg

(Gr. K+) Versatile 3x and 5x magnifiers. 0.75" and 1.5" diameter lens. 10/pkg

Microscope Slides



Blank Microscope slides - Glass - box of 72
CAT# B-14-248.....\$4.50 /BOX

Prepared Microscope Slides



Includes:
- Fibers
- Algae
- Grasshopper
- Fungi
- Starch
& more!

Set of 12 slides with 36 specimens.

CAT# B-14-246.....\$18.90 SET

Premium Large 2" Owl Pellets



Owl pellets are formed when owls swallow their prey whole, then cast a pellet out of their mouths 12 to 24 hours later. The pellet contains the indigestible bones and fur of the prey. They make a wonderful learning tool that can be used to introduce students to comparative skeletal anatomy, concepts of natural history, and ecology and predator/prey relationships.

Qty	\$ ea
1	\$8.50
2+	\$7.65

Toll Free 1.800.263.3556 • Toll Free Fax 1.800.731.8424 • www.kidder.ca

Prices are subject to change without notice

Newton Push/Pull Meters

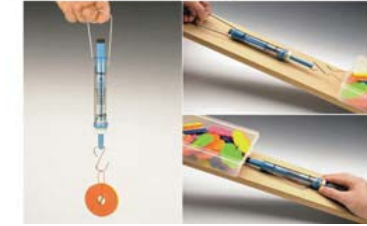

Low-cost spring balances provide a unique solution to the problem of measuring other compressive or tensile forces. These balances provide for measurements ranging from 2.5N to 50N.

Qty 1-1.....\$14.40 ea
2-UP.. \$13.45 ea

- A. CAT# 98-1205 Blue0-2.5 Newtons
- B. CAT# 98-1210 Green0-5 Newtons
- C. CAT# 98-1215 Beige.....0-10 Newtons
- D. CAT# 98-1220 Red0-20 Newtons
- E. CAT# 98-1225 White.....0-30 Newtons
- F. CAT# 98-1230 Yellow.....0-50 Newtons

Hooked Mass Weight Set



Set of 9 steel plated hex weights with hook ranging from 1g to 1kg. They are stored in a plastic fitted storage base.

CAT# 98-1305-00..... \$59.50 /SET OF 9

Hex Mass Weights



Hex mass weights include: 50, 100, 200, 500, 1000 g
Brass mass include : 10 and 20 g.
Supplied in a cardboard box.

CAT# 98-1309-00
\$51.50 /SET OF 5

Triple Beam Platform Balance w/ Weights



These balances feature rugged die cast construction, precision ground steel knife edges, dual magnetic dampening systems to slow oscillation, and a large stainless steel weighing platform.

- Capacity is 610g, and optional weight set extends capacity to 2610g.
- Notched and tiered beam, front beam calibration 0.1g sensitivity.
 - Middle beam 500 x 100g.
 - Rear beam 100 x 10g.
 - Platform size - 15cm diameter.

CAT# 19-1070.....\$166.00

Pulley Blocks



See pg 14 for pulley cord



Pulley blocks are free running 50 mm diam pulleys in a house with swivel hooks at each end.

Fig A...Single
CAT# 80-3594-01\$2.50

Fig B...Double
CAT# 80-3594-02\$3.60

Fig C...Triple
CAT# 80-3594-03\$5.35

The set of 5 pulleys blocks contains 2 single, 2 double, and 1 triple blocks.
CAT# 80-543594X\$14.95

Density Block Set



- 1 cm cube.
- The set consists of aluminum, steel, brass, copper, iron, wood, cork, lead, zinc and acrylic cubes.

CAT# 98-1180-00 \$24.75 /SET OF 10

Equal Mass Density Cubes



- Cube set includes 20g mass each of aluminum, brass, copper, iron and zinc.
- Packed in a cardboard box.

CAT# 98-1312-00 \$13.90 /SET OF 5

Balloon Helicopter Kit



Effectively demonstrates Newton's Third Law with this exciting and simple product. Balloon Helicopter kit contains: 1 balloon, 3 rotor blades, 1 mouth piece, 1 blade assembly. Air pump included. 12 kits/pkg

CAT# 99-7030-03...\$18.25 12/PKG

Acrylic Sheets 24" x 32" (69 x 81 cm) in Various Colours*

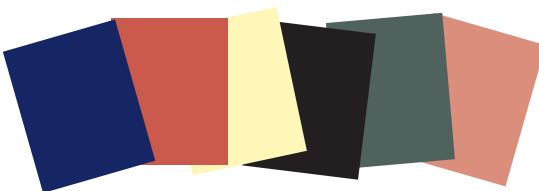

Cat#	Colour Thickness	1	2-5	6+
80-0101	Clear 1/8" (3 mm)	\$23.60	\$22.75	-
80-0103	Clear 3/16" (4.5 mm)	\$33.60	\$30.25	-
80-0104	Clear 1/4" (6 mm)	\$43.30	\$39.00	-
80-0301	White 1/8" (3 mm)	\$26.65	\$24.65	-
80-0303	White 1/4" (6 mm)	\$46.05	\$41.45	-
80-0307	Smoke 1/8" (3 mm)	\$38.40	\$35.95	\$34.20
80-0309	Smoke 1/4" (6 mm)	\$42.55	-	-
80-0312	Red 1/8" (3 mm)	\$26.65	\$24.00	-
80-0314	Red 1/4" (6 mm)	\$48.75	\$43.90	-
80-0317	Florescent Red 1/8" (3 mm)	\$43.90	39.50	-
80-0322	Green 1/8" (3 mm)	\$26.65	\$24.00	-
80-0324	Green 1/4" (6 mm)	\$43.90	\$39.50	-
80-0372	Florescent Green 1/8" (3 mm)	\$44.80	-	-
80-0327	Blue 1/8" (3 mm)	\$26.65	\$24.00	-
80-0329	Blue 1/4" (6 mm)	\$50.00	\$45.00	-
80-0332	Yellow 1/8" (3 mm)	\$26.65	\$24.00	-
80-0334	Yellow 1/4" (6 mm)	\$50.00	\$45.00	-
80-0337	Trans. Amber 1/8" (3 mm)	\$26.65	\$24.00	-
80-0342	Orange 1/8" (3 mm)	\$26.65	\$24.00	-
80-0344	Orange 1/4" (6 mm)	\$65.00	\$58.50	-
80-0347	Black 1/8" (3 mm)	\$26.65	\$24.00	-
80-0349	Black 1/4" (6 mm)	\$63.00	\$56.50	-
80-0369	Purple 1/8" (3 mm)	\$26.65	\$24.00	-
80-0503	Clear Mirror 1/8" (3 mm)	\$46.65	-	-

*Kidder may substitute equivalent colours when out of stock.

Assorted Off-Cuts of Acrylic

This package of acrylic has various coloured sheets. The thickness is mostly 1/8" - 1/4" (3-6 mm) and sheet sizes are mostly 2' x 3' (69 x 91 cm) and generally masked. This is an economical way to buy your acrylic.

Mostly 2' x 3' masked sheets!

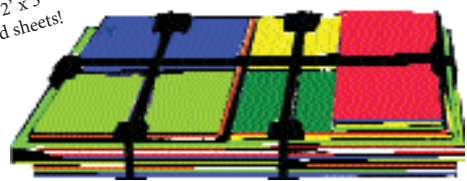

Cat#	Desc.	\$/Bundle
80-0703	75 lbs	\$370.00
80-0702	50 lbs	\$263.00
80-0701	25 lbs	\$135.00

Buy Bulk And \$ave

All sheets are 24" x 32"



Cat#	Qty	Colour	Thickness	Price
80-5401	12	Your Choice	1/8"(3mm)	\$295.00
80-5402	6	Your Choice	1/8"(3mm)	\$150.00
80-5414	6	Your Choice	1/4"(6mm)	\$280.00

Mirror Sheets



All mirror sheets 24" x 32" x 1/8". See 3" square mirrors on page 38.

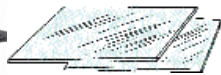

Cat#	Description	\$/Sheet
80-0503	Clear Mirror	\$46.65

Bulk Bead Chain & Connectors

Buy bulk and save costs. This chain comes in spools of 100'. You can purchase connectors to make your own



BULK BEAD 100 ft Spool CHAIN

Qty	\$ ea
1	\$38.00

CAT# 80-4217
Nickel Bead Chain 100' Sp
CAT# 80-4219
Brass Bead Chain 100' Sp

CONNECTORS

Qty	\$ ea
1	\$4.60
2-5	\$4.10

CAT# 80-4218
Nickel Connectors 100/pkg
CAT# 80-4220
Brass Connectors 100/pkg

Engraving Stock

This 2 ply engraving stock is perfect for sign making or CNC milling. The package comes with 6 sheets 12" x 24" (30 cm x 60 cm) assorted colours.

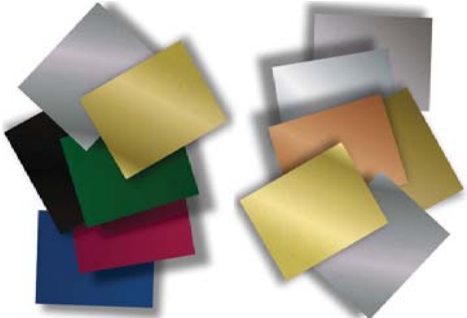

6 ASSORTED SHEETS
CAT# 80-5425-00...\$80.50

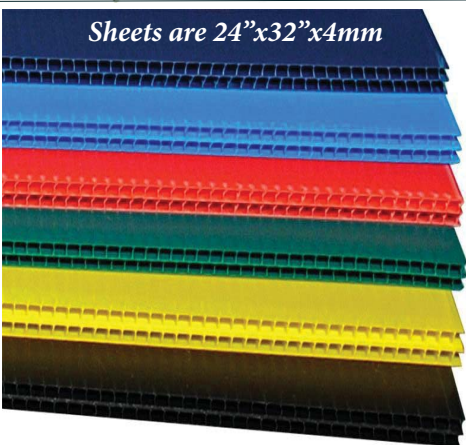

Sheets are 24"x32"x4mm

Corrugated Plastic*

The name Coroplast™ applies to a wide range of extruded twinwall plastic sheet products produced from a high impact polypropylene copolymer. This corrugated plastic sheeting is excellent for making small science projects. It is light, inexpensive and easy to use.

Cat#	Colour	1	2+
80-1247-00	Black	\$5.20	\$4.60
80-1227-00	Blue	\$5.20	\$4.60
80-1222-00	Green	\$5.20	\$4.60
80-1201-00	Natural	\$5.20	\$4.60
80-1212-00	Red	\$5.20	\$4.60
80-1203-00	White	\$5.20	\$4.60
80-1232-00	Yellow	\$5.20	\$4.60

7 Sheet Assorted Bulk Pack
CAT #80-54-1200..... \$28.00
(Kidder chooses the colours)

*3 Sheet minimum order for Corrugated Plastic

Toll Free 1.800.263.3556 • Toll Free Fax 1.800.731.8424 • www.kidder.ca

Prices are subject to change without notice



Plexweld "F" Solvent

Capillary cementing with Plexweld 'F' is an easy method of joining two pieces of acrylic. Finish the edges to a satin finish stage. Remove partially the masking. Hold pieces together by using vertical support. Apply Plexweld 'F' to inside corner with applicator.

A. CAT# 80-3401-GN	B. CAT# 80-3401-QT
4 Litre Tin	1 Litre Tin
\$85.50	\$31.85

Edge Scraper



This unique tool features four functions in one. Not only will it remove saw marks from flag edges, it also bevels thick and thin material and will radius the edge quickly and evenly.

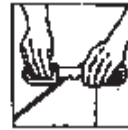

CAT# 80-3206-00

Qty	Price
1	\$16.90
2-up	\$15.00

Cutting Tool



Hardened steel blade scores and cuts acrylic up to 1/4" thick. Swivel blade folds away safely for storage, yet stays in place when scoring. Simply score material and break along the straight line.



CAT# 80-3205-00

Qty	Price
1	\$3.95
2-5	\$3.80
6 - up	\$3.35

Applicator for Plexweld



This squeeze type applicator is excellent for solvents such as Plexweld 'F'. It allows you to apply a very fine line of solvent. The long needle tip also allows you to get in to hard-to-get places. Bottles are 2 ounce and the needles are 25 gauge.

Replacement Needles

\$3.70 /5 Pkg



Cat.# 80-3405-RN

Qty	Price
1	\$3.70
2-5	\$3.40

CAT# 80-3405-00 2 oz applicator

Thickened Cement



A clear syrup cement for joining acrylic to acrylic where high strength joints are needed. Rapid setting, overnight cure formulation in an easy to use squeeze tube.

Ideal for Gluing most types of plastic.

Qty	Price
1	\$8.20
2-5	\$7.80
6 - up	\$7.20

CAT# 80-3404-00 2 oz

Plastic-Polish



Specially formulated for the removal of fine scratches, haziness and abrasions from most plastic surfaces. After polishing, use 20/20 Plasti-Cleaner to restore surface to a bright, shiny appearance.

Qty	Price
1	\$10.00

CAT# 80-2215-00

Olfa Heavy Duty Cutter

This professional cutter comes complete with a two sided tungsten carbide blade. The excellent grip handle offers ease in production and multiple use. Perfect for scoring and snapping Plastic! Just Score & snap!

CAT# 80-3209-00...\$16.35



Olfa Cutter Replacement blades
Cat# 80-3209-RB \$5.90/3 pack

Safety Goggles

General purpose goggles are important when working with any equipment and a good safety feature to stress with students.



Qty	Price
1	\$3.50
2-5	\$3.20
6-19	\$3.05
20+	\$2.75

CAT# 80-3219-00

Safety Glasses

These glasses have tough side shields, brow and nose bridge and one piece construction. They are offer excellent comfort, strength and stability.



Qty	Price
1	\$4.95
2-5	\$3.95
6-19	\$3.50
20-49	\$3.20
50+	\$2.90

CAT# 80-3229-00

Drill Bits for Acrylic & Wood

These drills are especially recommended for drilling acrylic plastic and most other types of plastic. They are made of high speed steel and are sold individually.



Cat#	Size	1	2 +
80-3210	1/8" (3.2 mm)	\$3.90	\$3.70
80-3211	5/32" (4 mm)	\$4.60	\$4.35
80-3212	3/16" (4.8 mm)	\$4.75	-
80-3213	1/4" (6.4 mm)	\$6.80	-
80-3214	5/16" (8 mm)	\$9.10	\$8.55
80-3215	3/8" (9.5 mm)	\$12.10	-
80-3216	7/16" (11 mm)	\$17.70	\$16.25
80-3217	1/2" (13 mm)	\$19.85	\$18.70

Sabre Saw Blades

These blades are especially designed for sawing acrylic plastic. There are 2 blades per package, one for sawing thin gauge material the other for 3/16" or thicker.

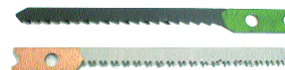

Qty	Price
1	\$4.95
2-up	\$3.95

CAT# 80-3204-00 2/PKG

Plastic Polish & Scratch Remover



Qty	Price
1	\$9.25
2-5	\$8.80
6 - up	\$8.35

Use to remove scratches or edge polish acrylic plastics. Kit contains 1/2 oz bottle of 20/20 Plastic Polish, 1/2 oz bottle of 20/20 Plastic Cleaner, polishing cloth, sanding block, 150 and 600 grit sandpaper and polishing instructions.

CAT# 80-3413-00



Cat#	Diameter	Length	1	2 +
80-0901-00	1/8" (3 mm)	91 cm (36")	\$0.54	\$0.50
80-0902-00	1/4" (6 mm)	91 cm (36")	\$1.26	\$1.16
80-0903-00	5/16" (8 mm)	91 cm (36")	\$1.80	\$1.65
80-0904-00	3/8" (9 mm)	91 cm (36")	\$2.60	\$2.40
80-0905-00	1/2" (13 mm)	91 cm (36")	\$4.25	\$3.90
80-0906-00	5/8" (16 mm)	91 cm (36")	\$8.35	\$7.55



Cat#	Diameter	Length	1	2 +
80-1102-00	1/4" (6 mm)	91 cm (36")	\$1.17	\$1.07
80-1103-00	3/8" (9 mm)	91 cm (36")	\$2.40	\$2.15
80-1104-00	1/2" (13 mm)	91 cm (36")	\$2.40	\$2.15
80-1105-00	5/8" (16 mm)	91 cm (36")	\$3.40	\$3.05
80-1106-00	3/4" (19 mm)	91 cm (36")	\$4.50	\$4.15
80-1107-00	1" (25 mm)	91 cm (36")	\$6.10	\$5.60

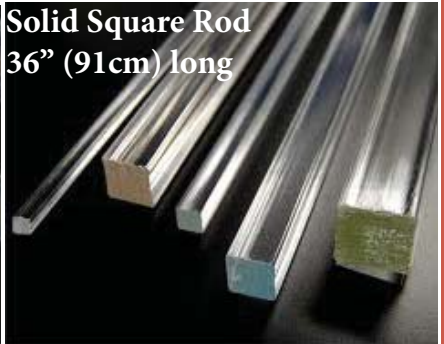

Cat#	Diameter	Length	1
80-1002-00	13 mm (1/2")	91 cm (36")	\$10.00
80-1004-00	19 mm (3/4")	91 cm (36")	\$17.50
80-1006-00	25 mm (1")	91 cm (36")	\$16.95

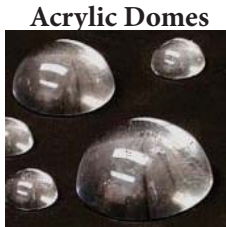
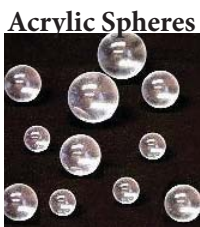

Cat#		Diameter	Pkg Size	1
80-1501-00	Sphere	6mm (1/4")	100/pkg	\$8.65
80-1502-00	Sphere	9mm (3/8")	100/pkg	\$26.40
80-1503-00	Sphere	13mm (1/2")	100/pkg	\$27.00
80-1504-00	Sphere	19mm (3/4")	25/pkg	\$21.00
80-1901-00	Cube	13mm (1/2")	25/pkg	\$10.80
80-1902-00	Cube	19mm (3/4")	25/pkg	\$20.10
80-1903-00	Cube	25mm (1")	10/pkg	\$18.10
80-1701-00	Dome	9mm (3/8")	100/pkg	\$16.00
80-1702-00	Dome	13mm (1/2")	100/pkg	\$22.40
80-1703-00	Dome	19mm (3/4")	50/pkg	\$35.65

Buffing Wheels

These high quality buffing wheels can be used on a bench press or grinding wheel arbour.

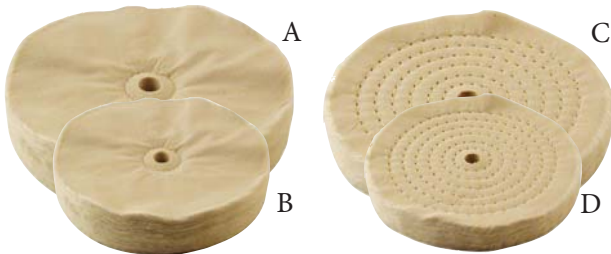

Fig.	Cat#	Description	Diam. & Thickness	Total Ply	Price
A	80-2203-00	School Buffer	8" (20 cm), 1" (4 cm)	80	\$36.00
B	80-2204-00	School Buffer	6" (15 cm), 1" (4 cm)	80	\$20.00
A	80-2205-00	Soft Flannel Polisher	8" (20 cm), 1" (4 cm)	15	\$19.85
C	80-2206-00	Sewn Buffer	8" (20 cm), 1"	80	\$36.00
D	80-2207-00	Sewn Buffer	6" (15cm), 3/4" (2cm)	80	\$20.00

Buffing Compound



A. Fast Cutting Compound

For a clear polished finish on cut edges of acrylic sheets, apply compound on loose buffer (80-2203). Wet sand first with duxex abrasive.

CAT# 80-2201-00...\$10.75

B. High Gloss Compound

For a highly polished final glass finish use this high gloss compound with the sewn buffers.

CAT# 80-2202-00...\$11.95

Arbour Adapter

This 5/8" arbour adapter fits 1/2" motor shaft.

**Cat# 80-2210
\$18.00 ea**



Hot Air Pistol Heat Gun 36" (91cm) long



This heat gun includes a 9 piece accessory kit for all your plastic forming needs. It has 1500 watts and is 120V. It reaches a temperature of 500°C.

CAT# 80-4836-00.....\$47.60

Clear Piano Hinges



This hinge is made from high strength resin for superior strength. It is solvent cementable for easy fabrication. This hinge can be cut to size.

Qty	\$ ea
1	\$3.80
2-5	\$3.70
6-19	\$3.60

CAT# 80-4252-00

Clear Acrylic Hinges

Use these hinges with all types of acrylic. Simply solvent cement in place with "Plexweld "F". No drilling, Tapping or mechanical fastener required.

Dimensions are 1 1/2" x 1 3/4" (388) mm x 44 mm)



CAT# 80-4247-00 2/PKG

Qty	\$ /pkg
1	\$3.65
2-5	\$3.35
6-19	\$3.05
20-49	\$2.70

Toll Free 1.800.263.3556 • Toll Free Fax 1.800.731.8424 • www.kidder.ca

Prices are subject to change without notice

Stripheater for Bending Acrylic

This heavy duty stripheater is designed to place a narrow strip of heat on an acrylic plastic sheet until it is soft and pliable enough to bend to the desired form. It is capable of heating sheets up to 1/2" thick.

- 110 volts
- Thermostatically controlled
- EMX-2 625 watts
- Pilot light with on/off switch
- CSA Approved
- Sturdy sheet metal construction
- Maximum temperature 450°f

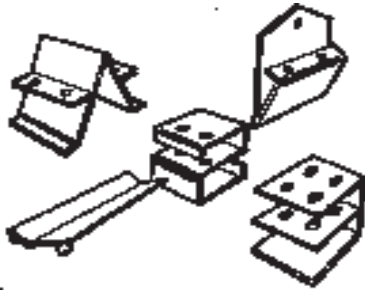
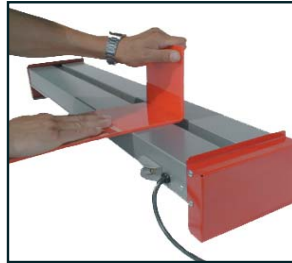

Model EMX-2...\$370.00
CAT# 80-4816-00
 48" (122 cm) Working Area
 7" Width (18 cm)



Straightline Benders

These free-standing heat trays are designed to give constant professional bends while working with all types of Thermoplastic materials. It is capable of heating up to 1/2" thick material. They run on standard 120 volt and have a maximum temperature of 800° f (426°C).

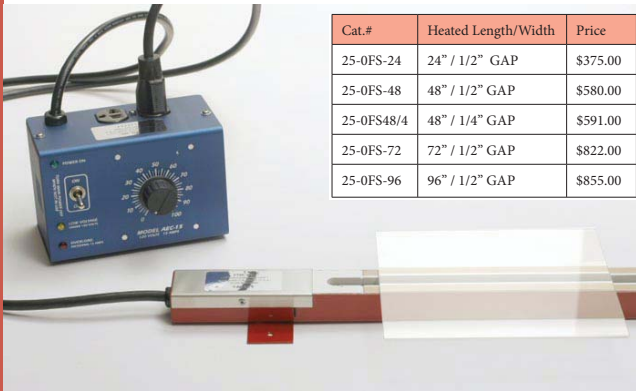

Cat.#	Heated Length/Width	Price
25-0FS-24	24" / 1/2" GAP	\$375.00
25-0FS-48	48" / 1/2" GAP	\$580.00
25-0FS48/4	48" / 1/4" GAP	\$591.00
25-0FS-72	72" / 1/2" GAP	\$822.00
25-0FS-96	96" / 1/2" GAP	\$855.00

Power Controls

These controls supply infinite control for AC power over the full range of input voltage. Adjustment of the input voltage accomplishes precise control, allowing exact matching of power to load requirements. 10 amp/120 volt.

CAT# 25-0AEC-15 15AMP.....\$476.00

Multi-Tray Heating System

This system prepares thermoplastic materials for forming all-angle bends reducing fabrication time. Unit has independently operated and moveable heating trays. Units are completely self-contained and require no special wiring.



- Dimensions: 62" wide x 54" depth x 5" height
- 48" wide x 48" depth working area
- approximately 68 lbs.
- 1 3/4" center to center closest parallel bend

Complete System

- CAT# 25-048-48E 1/2" Heat Gap 1/8" & thicker material..... \$3,248.00
- CAT# 2548-48E/4 1/4" Heat Gap .100" & thinner material \$3,544.00
- CAT# 25-0FS-48T Extra Heating Tray for above \$498.00

PRIMARY™ Thermoformer from

This fast, silent, easy to use unit is ideal for ages 6 and up. It is portable and easy to set up on a sturdy bench. It is ideal for Education and Model Making

Education

- Watch the entire process - your work is not hidden under another part of the machine
- Control what is happening - every step of the way
- Succeed first time
- Minimal cost of materials

Model-making

- Form over almost anything from fruit to plaster to wood to metals, even ice
- Plugs into household 110V outlet - no special wiring required
- No external compressor or vacuum pump required

Specifications

- Electrical Supply: 110V a.c. or 230V a.c. Version, 880W
- Safety: Compliant Hydro Approved
- Mass: 12kg (27lb)
- Dimensions: Width: 250mm (10"), Depth: 500mm (20"), Height 400mm (16")
- Sheet size: 265mm (10.5") x 215mm (8.5")
- Robust powder-coated steel and stainless steel construction
- Comes complete with manual, operation poster, sample pack of material - ready to go in minutes.

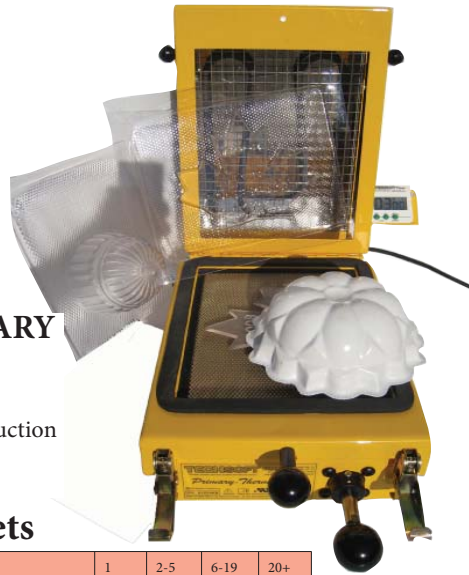

Cat# 75-PRIMARY

\$1659.00*

*Includes startup supplies, tutorial instruction manual, sheets.

Polystyrene Sheets

Cat#	Colour	Size	1	2-5	6-19	20+
75-V020BK	Black	14" x 20" (36 x 50cm)	\$4.15	\$39.5	\$3.50	-
75-V020BU	Blue	14" x 20" (36 x 50cm)	\$4.15	\$3.95	\$3.50	-
75-V020GR	Green	14" x 20" (36 x 50cm)	\$4.15	\$3.95	\$3.50	-
75-V020RD	Red	14" x 20" (36 x 50cm)	\$4.15	\$3.95	\$3.50	-
75-V020WH	White	14" x 20" (36 x 50cm)	\$3.80	\$3.60	\$3.20	\$3.00
75V.25CLRPF	Clr.25mm	8.5" x 10.5" (22 x 27cm)	\$72	\$68	-	-
75V.5CLRPF*	Clr.5mm	8.5" x 10.5" (22 x 27cm)	\$1.20	-	-	-
75V.8CLRPF*	Clr.8mm	8.5" x 10.5" (22 x 27cm)	\$1.40	\$1.33	-	-

T-Shirt Heat Transfer Machine

This Digital Clam Press is a great, economical heat press that works great in the shop or take it with you to events for on-demand printing. The Press is easy to operate with the digital time and temperature readout and over-the-center pressure adjustment. The upper flotation platen provides a flat, even surface. Used in conjunction with a heat printing pillow, there's nothing you CAN'T print! The Press is ideal for individuals who are just starting out in the industry, as a second press for home or the shop, or as a travel press that you take to live events like car shows, dance competitions, cheer events and more for complete on-demand heat printing and personalization!
CSA APPROVED!

Features of Heat Press

- * Digital Time & Temperature Readout
- * Patented Over-the-Center Pressure Adjustment
- * Teflon Coated Heat Platen
- * HRPO Laser Quality Steel Framework
- * Smooth Shock Opening. Easy open!
- * Scratch Resistant, Baked on Powder Coat Finish
- * UL/ULC/CE/RoHS Approved
- * CE/NRTLCO Approved Over-the-Center Pressure Adjustment • Upper heating element has non-stick coating
- Cast-In Tubular Heating Element every 2" eliminates cold spots
- Opens wide for easy layout

Ink Jet Transfer Paper 8.5" x 11"

With the aid of a PC, an ink jet printer, Heat Transfer Paper and a heat transfer machine or iron you can instantly turn that good idea into a beautiful ready-to-wear full colour garment!

CAT# 2-0000TJ11

Quantity	\$
1	\$2.05
2-5	\$1.67
6-19	\$1.59
20+	\$1.55

Premium Heat Transfer Paper 8.5" x 11"

Premium Trans is the next generation in heat transfer papers. It can be applied to T-shirts, sweat-shirts, aprons, bags, caps, mouse pads, coated mugs, wood, and some nylons. It is designed to run in most colour copiers and colour printers (except ink jet). It's applications also include liquid markers, crayons, and soft lead pencils. Premium Trans can be hot peeled for a satin look or cold peeled to produce a glossy look.

CAT# 2-0000PT11

Quantity	\$
1	\$2.25
2-5	\$1.93
6-19	\$1.46
2-49	\$1.39
50+	\$1.31



Cat#2-00DP1515

\$895.00

Toll Free 1.800.263.3556 • Toll Free Fax 1.800.731.8424 • www.kidder.ca

Prices are subject to change without notice

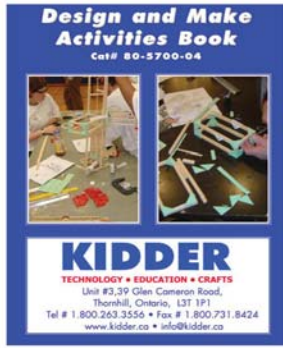

A. 80-5700-04

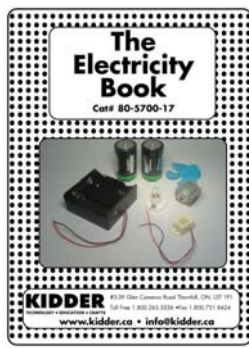

B. 80-5700-17



C. 80-5710-EN

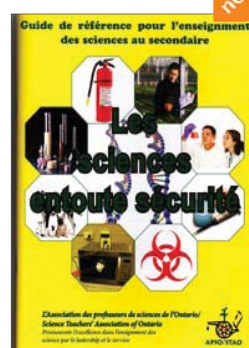

D. 80-5710-FR



E. 80-5711-00



F. 80-5700-06



G. 80-5702-00



H. 80-5700-03



I. 70-1400-02

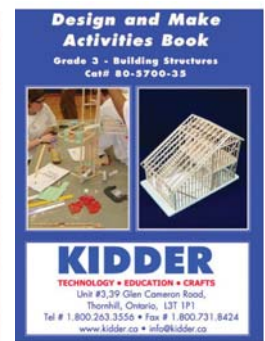

J. 80-5700-35

A. Design and Make Activities

A photocopiable resource that contains 12 indexed sections to cover Science and Technology design and make project work. Full of ideas, challenges and hints and tips. Subjects covered include levers, electricity, hydraulic, simple machines, alternative energy and much more.

Cat# 80-5700-04...\$39.70

B. The Electricity Book

An introduction to simple circuits and making your own switches with plenty of illustrated examples to stimulate classroom activities, including bulbs, motors, buzzers and batteries. 20 pages

Cat# 80-5700-17...\$10.50

C. Safe On Science

This book was written by STAO/APSO's Safety Committee, a panel of experienced teachers with a strong background in science safety. Topics include legislation, general safety considerations, emergency procedures, classroom considerations and specific considerations for Physics, Chemistry and Biology. Find out why several school boards in Ontario rely on Safe ON Science as a core safety resource for their teachers.

Cat.#80-5710-EN..\$16.75

D. Les Sciences en Toute Sécurité

Cette ressource est écrite par le comité d'APSO de la sécurité, un groupe d'enseignantes/enseignants expérimentés ayant une expérience solide en matière de sécurité en sciences. Les sujets traités comprennent la réglementation et les lois, les considérations générales de sécurité, les procédures d'urgence, les considérations pédagogiques et en particulier à propos de la physique, chimie et biologie.

Cat.# 80-5710-FR..\$16.75

E. Safety in Elementary Science & Technology

This 109 page resource is the result of a partnership with TDSB. It was written by teachers for teachers and administrators, to provide guidance for the safe delivery of hands-on science and technology programs to students. The planning framework used throughout the resource helps teachers to identify hazards, assess risks and make safety plans. If you want a single reference source for dealing with safety in the elementary classroom, this is the one for you.

Cat.# 80-5711-00..\$20.95

F. Design Technology - Elementary Engineering

An invaluable aid for the busy teacher. These help sheets contain teacher's notes with lots of sketches showing process and techniques. Each sheet deals with a theme and suggests ideas, tasks and activities for it.

80-5700-06.....\$13.00

G. Techniques for Technology

This book contains ideas, hints and tips and challenges for the student new to design and make Technology syllabus. It has 144 pages.

Cat# 80-5702-00...\$35.90

H. Teaching Techniques Book

Each activity in this book contains a teachers page and photocopiable student pages. Focus is on open ended problem solving using moving models.

Cat# 80-5700-03...\$10.55

I. Look What you Can Make with Craftsticks

This book features large, full-color photographs, simple step-by-step instructions, and a wealth of idea sparkers that will yield hours of craft-making fun. More than 80 pictured crafts and dozens of other ideas in every book. Crafty kids, parents and teachers will love these projects! (All Grades)

Cat.# 70-1400-02.....\$7.15

J. Design and Make Activities Book Building Structures

This book contains information on the safe use of tools, and an introduction to popular materials. There are many activities on building and testing strength design. It also includes many helpful techniques.

Cat# 80-5700-35...\$19.90

Hands on Science and Technology Series-Ontario Curriculum

Revised to match the new Ontario science and technology curriculum.

\$99.50 EA

The Hands-On Science and Technology series is an instructional program for teachers of grades 1 to 6 science. Based on recent research in science education, Hands-On Science and Technology assists teachers in developing students' scientific literacy through active inquiry, problem solving, and decision-making. The program is activity-based and child-centred, meaning that students are engaged in hands-on activities in a real-life context to explore the world around them. Using themes from the Ontario Curriculum Grades 1-8 Science and Technology (2007), the Hands-On Science and Technology series provides instructional support for teachers. Each grade-level resource has four instructional units. Each unit is complete with suggested websites and books for children, science vocabulary lists, science background information, detailed lesson plans focusing on specific curricular expectations, and blackline masters for lesson visuals and activity sheets. The resource guide also offers a comprehensive and authentic assessment plan that focuses on the Achievement Levels outlined in the Ontario Science and Technology Curriculum.

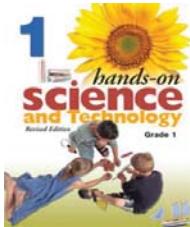

Cat# 80-5796-G1

Grade 1 Resource

- Unit 1:
Needs and Characteristics of Living Things
- Unit 2:
Materials, Objects, and Everyday Structures
- Unit 3:
Energy in Our Lives
- Unit 4:
Understanding Earth and Space Systems

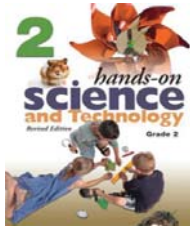

Cat# 80-5796-G2

Grade 2 Resource

- Unit 1
Growth and Changes in Animals
- Unit 2:
Movement
- Unit 3
Properties of Liquids and Solids
- Unit 4
Air and Water in the Environment

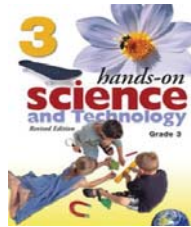

Cat# 80-5796-G3

Grade 3 Resource

- Unit 1
Growth and Changes in Plants
- Unit 2
Strong and Stable Structures
- Unit 3
Forces Causing Movement
- Unit 4:
Soils in the Environment



Cat# 80-5796-G4

Grade 4 Resource

- Unit 1
Habitats and Communities
- Unit 2
Pulleys and Gears
- Unit 3
Light and Sound
- Unit 4
Rocks and Minerals



Cat# 80-5796-G5

Grade 5 Resource

- Unit 1
Human Organ Systems
- Unit 2
Forces Acting on Structures and Mechanisms
- Unit 3
Properties of and Changes in Matter
- Unit 4
Conservation of Energy and Resources



Cat# 80-5796-G6

Grade 6 Resource

- Unit 1
Biodiversity
- Unit 2
Flight
- Unit 3
Electricity and Electrical Devices
- Unit 4
Space

Design and Make Folios

This is a series of 10 photocopiable booklets for teachers that cover many aspects of technology education. The folios contain a wealth of information for the elementary classroom focusing on the "Jinks construction systems" pioneered by David Jinks. Each folio is based on his successful professional development courses for teachers. These are the definitive books to help all teachers in the field.



\$15.95 EA



- Technology in Perspective.....Cat# 8057JINK01
- Tools and MaterialsCat# 8057JINK02
- Box Modeling.....Cat# 8057JINK03
- Frames and StructuresCat# 8057JINK04
- Making Things MoveCat# 8057JINK05
- Mechanisms 1: Pulleys, Winches, Cams.....Cat# 8057JINK06
- Electric's.....Cat# 8057JINK09
- Mechanisms 2: Gears, Belts, Conveyors.....Cat# 8057JINK07
- Mechanisms 3: Levers, Hinges, Fluidics.....Cat# 8057JINK08
- Complete set of 9 BooksCat# 805457JKAL

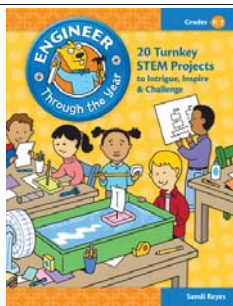

Engineer Through the Year K-2

20 Turnkey STEM Projects to Intrigue, Inspire & Challenge
This book inspires every student with real-world, hands-on engineering challenges. Build on children's natural curiosity to develop critical thinking, creativity, collaboration, communication, and problem-solving skills. (K-2) 176 pp.

Cat# 80-5700-55....\$34.00

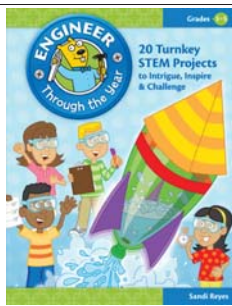

Engineer Through the Year

20 Turnkey S.T.E.M. Projects to Intrigue, Inspire & Challenge
Is it possible to develop basic engineering skills as early as grades 3-5 without adding to the existing curriculum? You bet! The exciting challenges in this book bring out children's natural curiosity. With Engineer Through the Year, students build engineering skills all year long. 198pp.

Cat# 80-5700-56....\$35.70

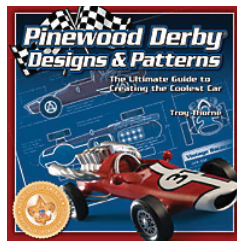

Pinewood Derby Designs & Patterns

Build the coolest car in the pinewood derby. This guide provides 34 amazing patterns and designs along with step-by-step instructions for building a High-Wing Racer, a Stock Car and a Vintage Racecar.

Cat# 80-5793-00...\$19.45

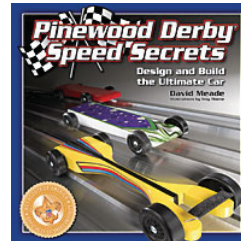

Pinewood Derby Speed Secrets

This book has hundreds of colour photographs, and clear diagrams and illustrations. The step-by-step instructions enable readers to build the car body, prepare the axles and improve the wheels with minimum tools.

Cat# 80-5792-00...\$19.45

Wood Pallet Projects



Lumber prices are soaring, and deforestation is a rising concern. Yet millions of pounds of perfectly usable wood are dumped in landfills every year. Wood Pallet Projects shows how anyone can upcycle salvaged pallet wood to create truly one-of-a-kind projects. Maverick craftsman Chris Gleason combines sound woodworking techniques with a hip designer's sensibility to unleash the limitless possibilities of the common skid.

Cat# 70-1400-01...\$25.65

*See Pine Derby Supplies Page 13)

Toll Free 1.800.263.3556 • Toll Free Fax 1.800.731.8424 • www.kidder.ca

Prices are subject to change without notice

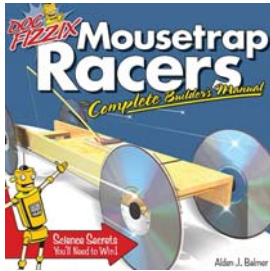

A. 80-5758-00



B. 70-1486-01



C. 80-5700-02



D. 80-5700-01

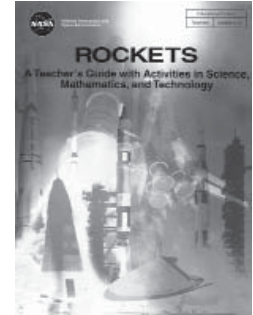

E. 80-5746-00

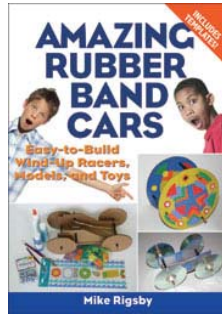

F. 80-5779-00



G. 70-1491-00



H. 70-1497-00

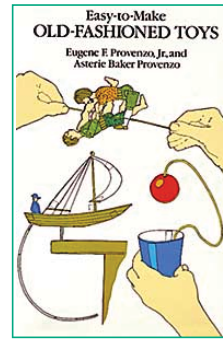

I. 70-1494-00

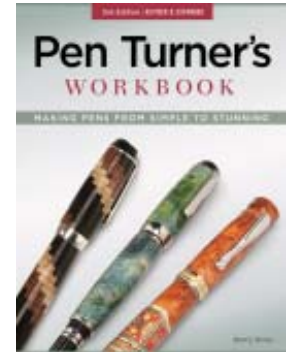

J. 70-1469-00

A. Doc Fizzix Mousetrap Racers

Kids are naturally curious. They love to build stuff and projects that involve cars will entertain children for hours. In this guide written by a Teacher-of-the-Year winner, your kids will learn how to construct race cars from ordinary, affordable household materials, while learning the science behind how they work, in language easy enough for a 7th grader to understand.

Cat# 80-5758-00...\$19.05

F. Amazing Rubber Band Cars

Combining fun and interactive activities, this guide will have kids captivated for hours constructing fantastic racing cars with the basics of only rubber bands, cardboard, and glue. These simple instructions with templates allow budding engineers to gain hands-on experience as they learn how to build a basic racer and make modifications to get better performance.

Cat# 80-5779-00...\$12.95

E. Zany Wooden Toys

This simple to follow guide includes patterns, step-by-step instructions, and engineering advice on how to make 28 different toys. There is even a section on toy-making basics that offers a supply list, time saving tips and a how-to on doing the projects with small children. The majority of the projects in the book can be completed in an hour, but will be sure to provide hours of entertainment.

Cat# 70-1486-01...\$29.95

G. Woodworking Techniques & Projects for the First Time Woodworker

Woodworking is a useful and enjoyable skill that anyone can learn. If you've ever wished you knew how to make things out of wood, this book is the perfect place to start. You'll be amazed at how simple it is to build fun and practical wooden items as you work through the easy lessons inside. Each of the woodworking projects in this book can be completed in just a few hours.

Cat# 70-1491-00...\$15.80

C. The Inventa Book of Structures

An excellent resource for teachers to gain some valuable insight into structures. This book uses illustrations to explain concepts in a way that is clear, straight-forward and easy to understand.

Cat# 80-5700-02...\$43.10

H. The Big Book of Weekend Woodworking

This book is filled with 150 classic projects, and covers everything from selection the wood to gluing and finishing. Novices can make simple mirrors or shelves, while more advanced woodworkers can try a small cupboard or side table.

Cat# 70-1497-00...\$24.10

D. The Inventa Book of Mechanisms

This book explores the development and concepts involved in a range of basic mechanisms including pulleys, gears, levers and ramps. It uses clever cartoons and illustrations to describe some complex concepts in an accessible manner.

Cat# 80-5700-01...\$43.10

I. Easy to Make Old Fashioned Toys

Fun and easy toys that bring back memories of the past. This book is a great way to connect with kids.

Cat# 70-1494-00...\$16.15

E. ROCKETS
A Teacher's Guide with Activities in Science, Mathematics, and Technology

This manual is loaded with information on the history of rocket and rocket principles. It has several activities some of which are Rocket Racer, Newton Car, Bottle Rocket Launcher, and Balloon Staging. It also lists suggested readings. It is compiled by NASA.

Cat# 80-5746-00...\$19.90

J. Pen Turner's Workbook Third Editions

Learn to make pens that are both practical--and beautiful! In this newly revised edition, author and expert pen turner, Barry Gross provides new pen kits and mechanisms with up-to-date techniques, along with in-depth instruction and creative ideas for both the novice and the experienced turner looking for new ideas.

Cat# 70-1469-00...\$26.00

The "RD Series" Mini Quartz Movement



- 6 Shaft lengths available
- 2 year warranty
- Case dimensions 6 cm x 6 cm x 1.6 cm (2 7/32 w x 2 7/32" x 5/8"d)
- Uses 1 "AA" cell battery (Cat.# 70-3201 which lasts up to 2 years (see pg.18)
- FREE hour, minute and second hand (see pg. 61)
- Mounting hardware included (brass washer, hex nut, rubber washer, minute nut)
- 8mm (5/16") Shaft Diameter

Cat.#	Shaft Length	For Dials Up To
70-7101-NS	3mm (1/8")	3 mm (1/8")
70-7102-NS	6mm (1/4")	5 mm (3/16")
70-7104-NS	10mm (3/8")	6 mm (1/4")
70-7106-NS	12mm (1/2")	9 mm (3/8")
70-7107-NS	16mm (5/8")	12 mm (1/2")
70-7108-NS	20mm (13/16")	19 mm (3/4")

Actual Shaft Length (threaded stem)

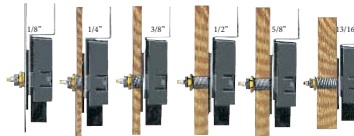

Minute Nut Driver

No more fumbling for minute nuts. This tool picks up the nut and grips it securely .



Cat # 70-3824-00...\$37.30

Tool Nut Tightener

This tool is very handy when repairing or making clocks.



Cat# 70-3801-00...\$2.75

Forstner Bit

This will make a hole to fit the RD mini movements. Bit diameter is 3 1/8"



Cat. # 70-3802-00 \$28.30

(See pg 66 for more sizes)

MP Pendulum Movements

- Slimline design is great for small cases
- Runs on one "AA" cell battery (70-3201) See pg. 14
- Pendulum hook is 10mm (3/8") from front of movement
- Case dimensions 90 mm x 50 mm x 20 mm (3 1/2 h x 2 1/8" w x 7/8" depth)
- For free hands see page 53
- Adjustable pendulum from 180 mm - 460 mm (7" - 18")
- Bob diameter is 70mm (2 3/4")
- Pendulum swings from 114 mm x 178 mm (4 1/2" - 7") depending on length
- 8mm (5/16") Shaft Diameter

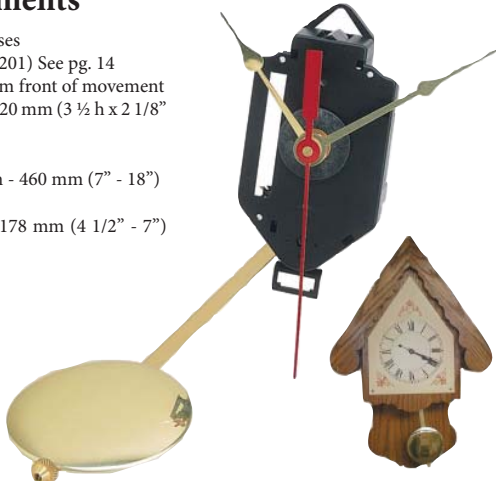

Smaller 2" bob is available. Just add SM to the end of the number instead of 00

Cat#	Shaft Length	Qty 1	2-5	6-19	20-UP
70-6112-00	10mm (3/8")	\$18.65	\$16.80	\$15.00	\$14.15
70-6012-00	16 mm (5/8")	\$18.65	\$16.80	\$15.00	\$14.15
70-6212-00	22 mm (7/8")	\$18.65	\$16.80	\$15.00	\$14.15

Lyre Attachments

Now your quartz movements can have a beautiful lyre pendulum. Just add these attachments to a pendulum 12" (30 cm) or longer with a width from 1/16" - 3/16" (2 x 3 mm). The dimensions are approximately 2" x 4" (50 x 101 mm). Lyre attachments work well with our QW and MP movements.



Qty	\$ ea
1+	\$2.85

Cat# 70-0026-00*

*bob and stem not included

Lyre attachments work well with our QW and MP movements.

Hand Protectors

Protect your clocks when shipping or transporting with these clear plastic hand protectors.

- A) Cat# 70-2143-00
Hands up to 139mm (5 1/2")
- B) Cat# 70-2145-00
Hands up to 85mm (3 5/8")

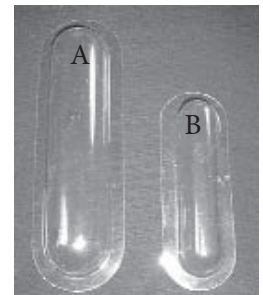

Qty	\$ ea
1	60¢
2+	54¢

Request your FREE template.
Cat# 80-5908-00

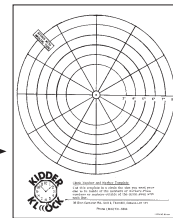

Clock Kit 20 Student Class Pack

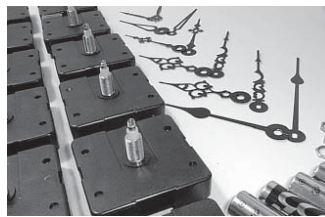

This class pack includes 20 clock movements with assorted shaft lengths, hands, second hands and batteries.

Cat# 70-5405.....\$93.50

Extra Assorted Hands & Numeral Packs

- A) Assorted Hand Packs
Cat# 70-5412-20 20 Set Pack \$26.50
Cat# 70-5412-50 50 Set Pack \$49.50
- B) Numeral Packs
Cat# 70-5409-20 20 Set Pack \$24.50
Cat# 70-5409-50 50 Set Pack \$42.50



QW Westminster Chime

This Westminster chime movement is an economical choice to add sound to all your clock projects.



- Plays Westminster melody on quarter hours and counts out the hours
- Runs on one "C" cell battery (70-3203) See pg. 18
- Pendulum hook is 5/8" (16 mm) from front of movement
- Case dimensions 3 3/4" h x 3" w x 1 1/8" d (10 cm x 8 cm x 3 cm)
- For free hands see page 61
- Adjustable pendulum from 8" - 19" (20 cm - 48 cm)
- 3/8" (10 mm) shaft diameter

Cat#	shaft Length	Pend.Length	1	2-5	6-19	20-49	50-up
70-6401-00	3/8" (10 mm)	no pendulum	\$38.45	\$33.95	\$30.45	\$28.75	\$25.90
70-6301-00	3/4" (19 mm)	no pendulum	\$38.45	\$33.95	\$30.45	\$28.75	\$25.90
70-6414-00	3/8" (10 mm)	with pendulum	\$45.20	\$40.15	-	-	-
70-6314-00	3/4" (19 mm)	with pendulum	\$39.95	\$35.50	-	-	-

Tubular 5 Chime Movement

This 5 chime movement simulates tubular bell sound with superior sound quality.

- Plays Westminster, Ave Maria, Bim Bam, or Gong on the hour and quarter hours
- Volume control & night silencer
- 15 1/2" Lead Wires
- Shaft Diameter: 3/8"
- 2 shaft lengths available
- Movement Size: 4 7/16"H x 4 5/8"W x 1 1/4"D
- Chime Case Size: 3 1/16"H x 2 5/16"W x 1 1/4"D
- 16" pendulum can be cut to length
- Free pair of hands (see pg. 61)
- Requires two C batteries 70-3203-00



Cat#	Shaft Length	Pend.Length	1	2-5	6+
70-4301-00	3/8" (10 mm)	no pendulum	\$61.00	-	-
70-4601-00	11/16" 17.5mm	no pendulum	\$59.00	\$57.50	-
70-4313-00	3/8" (10 mm)	with pendulum	\$63.00	-	-
70-4613-00	11/16" 17.5mm	with pendulum	\$63.00	\$59.50	\$56.00

High Torque "AA" Movement

This movement is capable of running the longest hands on the market. Case dimensions 2 7/32" square x 5/8" depth. It uses 1 "AA" cell battery (cat.# 70-3201) Hands are sold separately and are available in black only.

Qty	\$/Each
1	\$10.75
2-5	\$9.60
6+	\$8.95



18" barnwood clock



CAT# 70-0904BHT 3/16" Shaft Length

CAT# 70-0908BHT 3/4" Shaft Length

Hands sold separately

High Torque Hands

CAT# 70-1595-00 8 1/16" \$4.25



CAT# 70-1598-00 13 3/4" \$14.50

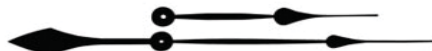

CAT# 70-1599-00 10" \$14.40

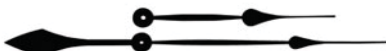

CAT# 70-1596-00 14 3/8" \$14.50



CAT# 70-1594-00 12" \$6.20



CAT# 70-1593-00 17.5" \$12.80



Clock Hub

new

Create a personalized wall clock with this plastic clock hub. This unit conceals a non-pendulum quartz clock movements and includes cover, backplate, screws, and built-in hanger.



Works with movements 2-7/32"H x 2-7/32"H x 5/8"D. We recommend using this hub with our short shaft high torque movement 70-0904BHT.

Dimensions: 3-3/8" dia. X 1"D

Cat# 70-2142-00

Qty	\$ Each
1	\$3.95
2-5	\$3.45

Set & Forget Movements

Set & Forget® is a patented technology that makes clocks automatically spring forward and fall back when the Daylight Saving Time change occurs twice a year. No radio signals required! This quartz clock movement contains an internal microchip calendar that is pre-programmed until the year 2098, so you'll won't need to manually set the date. Features an encapsulated gear train inside the clock movement, designed to keep debris out of the gears for years of trouble-free operation.



*Free hands included - see Page 61

Qty	\$ Each
1	\$13.20
2-5	\$11.55
6+	\$10.85

Cat#	Maximum Dial Length
70-9112-00	5mm (3/16")
70-9114-00	16 mm (5/8")

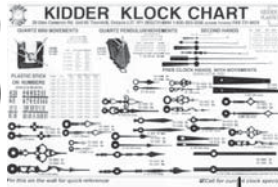
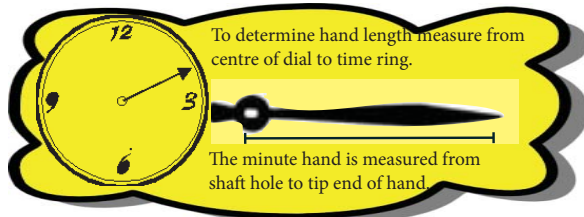

For your FREE hand chart please request Cat# 80-5907-00

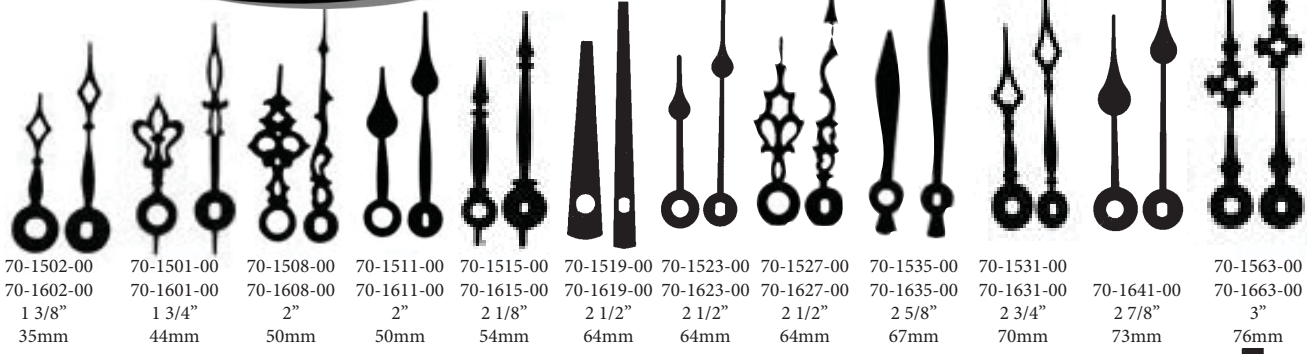

Hand Pricing

QTY	1	2-5
\$/Set	\$1.10	.95

Black hands 70-15XX's
Gold hands 70-16XX's

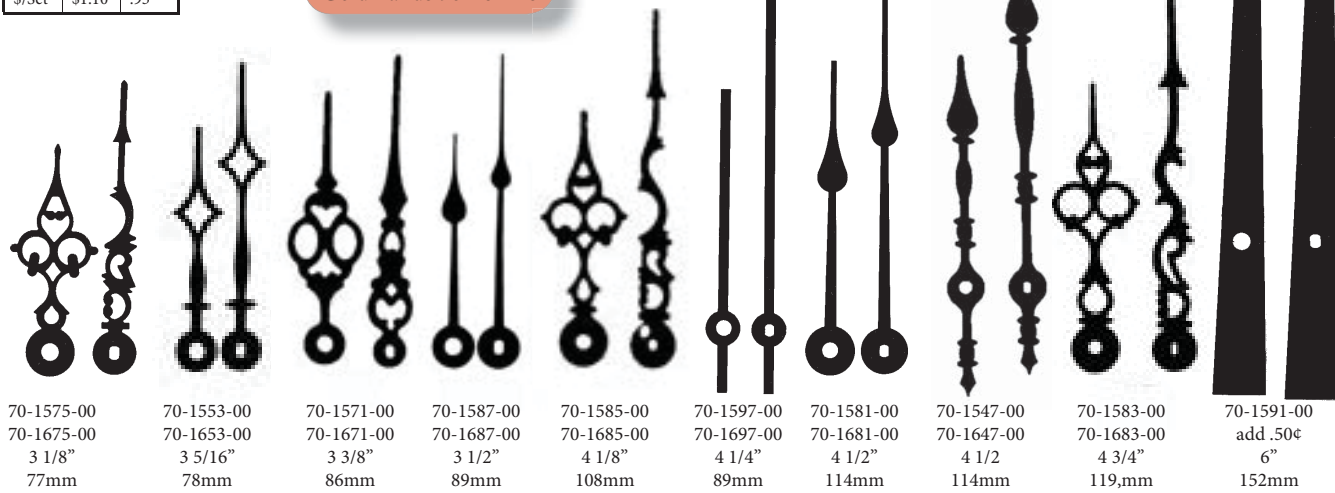

70-1542-00	70-1543-00	70-1544-00
Fishing Rods	Silverware	Tools
2 7/8"	3 1/2"	4 3/8"
73mm	89mm	111mm

**add .50 for these specialty hands

Clock Hand Protectors

Protect your clocks when shipping or transporting with these clear plastic hand protectors.

Cat# 70-2143-00
Hands up to 5 5/8"

Qty	\$ ea
1	\$.70
2-5	\$.63

Cat# 70-2145-00
Hands up to 3 5/8"

Qty	\$ ea
1	\$.60
2-5	\$.54
6-19	\$.51

Second Hands

Qty	\$ Each
1	\$1.10
2-5	\$0.95

Second hands free with movements

Fig	Length	Gold	Black	Red
A	1 5/16" (33 mm)	70-1723	70-1724	70-1725
B	2 1/2" (63 mm)	70-1719	70-1720	70-1721
C	3" (76mm)	70-1717	70-1718	N/A
D	2 3/4" (69 mm)	70-1707	70-1709	70-1708
E	3 1/2" (89 mm)	70-1714	70-1716	70-1715
F	4 1/2" (114 mm)	N/A	N/A	70-1712



Qty	\$/set
1	\$1.55
2-5	\$1.40

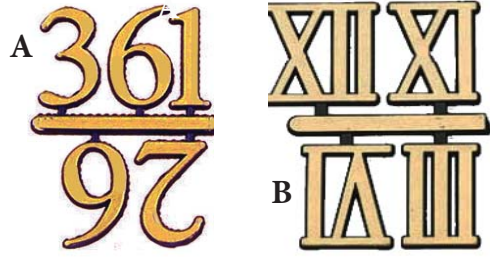

Qty	\$/set
1	\$.75
2-5	\$.70

A. 12 Digit Arabic

B. 12 Digit Roman

Colour	Size	Cat #	Colour	Size	Cat #
Gold	3/8" (10 mm)	70-3008-00	Gold	3/8" (10 mm)	70-3022-00
Black	3/8" (10 mm)	70-2908-00	Black	3/8" (10mm)	70-2922-00
Gold	1/2" (13 mm)	70-3009-00	Gold	1/2" (13 mm)	70-3023-00
Black	1/2" (13 mm)	70-2909-00	Black	1/2" (13 mm)	70-2923-00
Gold	5/8" (16 mm)	70-3010-00	Gold	5/8" (16 mm)	70-3024-00
Black	5/8" (16 mm)	70-2910-00	Black	5/8" (16 mm)	70-2924-00
Gold	3/4" (19 mm)	70-3011-00	Gold	3/4" (19 mm)	70-3025-00
Black	3/4" (19 mm)	70-2911-00	Black	3/4" (19 mm)	70-2925-00
Gold	1" (25 mm)	70-3012-00	Gold	1" (25 mm)	70-3026-00
Black	1" (25 mm)	70-2912-00	Black	1" (25 mm)	70-2926-00
Gold	1 1/4" (32 mm)	70-3013-00	Gold	1 1/4" (32 mm)	70-3027-00
Black	1 1/4" (32 mm)	70-2913-00	Black	1 1/4" (32 mm)	70-2927-00

A. 4 Digit Arabic

B. 4 Digit Roman

Colour	Size	Cat #	Colour	Size	Cat #
Gold	3/8" (10 mm)	70-3001-00	Gold	3/8" (10 mm)	70-3015-00
Black	3/8" (10 mm)	70-2901-00	Black	3/8" (10 mm)	70-2915-00
Gold	1/2" (13 mm)	70-3002-00	Gold	1/2" (13 mm)	70-3016-00
Black	1/2" (13 mm)	70-2902-00	Black	1/2" (13 mm)	70-2916-00
Gold	5/8" (16 mm)	70-3003-00	Gold	5/8" (16 mm)	70-3017-00
Black	5/8" (16 mm)	70-2903-00	Black	5/8" (16 mm)	70-2917-00
Gold	3/4" (19 mm)	70-3004-00	Gold	3/4" (19 mm)	70-3018-00
Black	3/4" (19 mm)	70-2904-00	Black	3/4" (19 mm)	70-2918-00
Gold	1" (25 mm)	70-3005-00	Gold	1" (25 mm)	70-3019-00
Black	1" (25 mm)	70-2905-00	Black	1" (25 mm)	70-2919-00
Gold	1 1/4" (32 mm)	70-3006-00	Gold	1 1/4" (32 mm)	70-3020-00
Black	1 1/4" (32 mm)	70-2906-00	Black	1 1/4" (32 mm)	70-2920-00



Head to www.kidder.ca for more Numeral options!



Head to www.kidder.ca for more dial & glass bezel options!

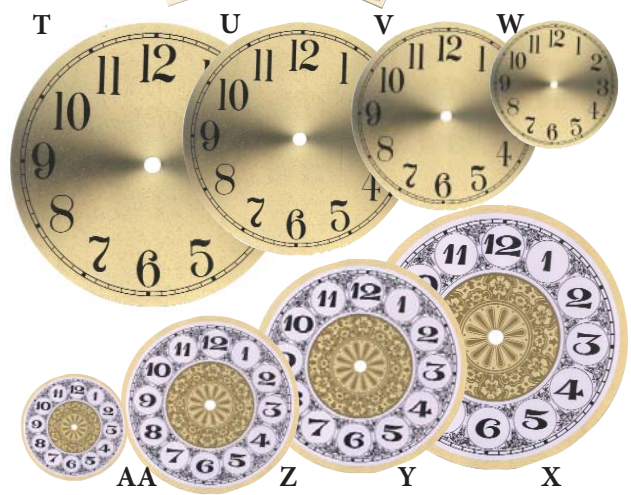
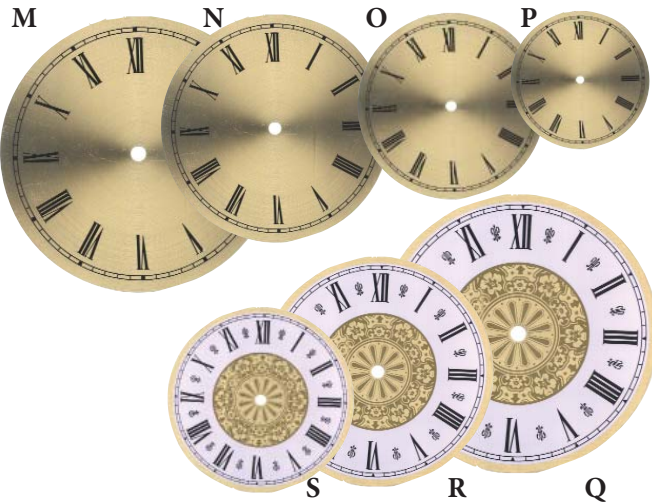

Fig	Cat#	Size	Sugg Hands	Price
M	70-2386-00	200mm (7 7/8")	70-1587-00	\$6.30
N	70-2383-00	178mm (7")	70-1541-00	\$6.10
O	70-2382-00	150mm (6")	70-1523-00	\$5.50
P	70-2326-RM	128mm (5")	70-1511-00	\$4.15
Q	70-2319-50	200mm (7 7/8")	70-1587-00	\$8.40
R	70-2319-07	178mm (7")	70-1541-00	\$7.65
S	70-2319-01	150mm (6")	70-1523-00	\$6.95

Fig	Cat#	Size	Sugg Hands	Price
T	70-2328-00	200mm (7 7/8")	70-1587-00	\$7.60
U	70-2381-00	178mm (7")	70-1541-00	\$6.00
V	70-2384-00	150mm (6")	70-1523-00	\$5.50
W	70-2326-AR	128mm (5")	70-1511-00	\$4.15
X	70-2318-08	200mm (7 7/8")	70-1587-00	\$8.40
Y	70-2318-02	178mm (7")	70-1541-00	\$7.65
Z	70-2318-00	150mm (6")	70-1523-00	\$6.95
AA	70-2300-27	107mm (4 1/4")	70-1511-00	\$3.75

Unit#3-39 Glen Cameron Road, Thornhill, ON, L3T 1P1
Prices are subject to change without notice

Inserts 89mm (3 1/2") Diameter

These 89mm (3 1/2") inserts have a 76mm (3") mounting diameter (forstner bit 70-3816-00) and take an AA cell battery (70-3201-00). You can mix and match for quantity pricing.

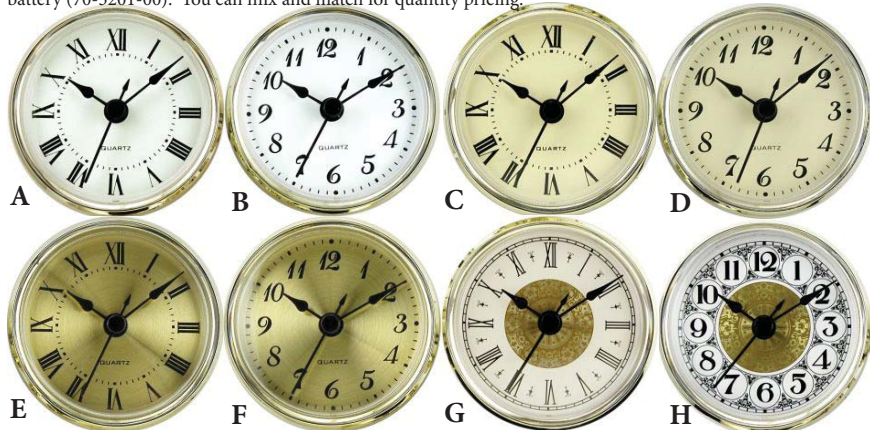
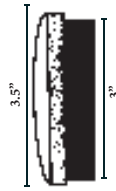

Fig	Cat#	Description	QTY 1	2-5	6-19	20-49	50-UP
A	70-1147-WR	White Roman	\$10.50	\$9.45	\$8.40	\$7.55	\$6.70
B	70-1148-WA	White Arabic	\$10.50	\$9.45	\$8.40	\$7.55	\$6.70
C	70-1147-CR	Ivory Roman	\$10.50	\$9.45	\$8.40	\$7.55	\$6.70
D	70-1148-CR	Ivory Arabic	\$10.50	\$9.45	\$8.40	\$7.55	\$6.70
E	70-1147-00	Gold Roman	\$10.50	\$9.45	\$8.40	\$7.55	\$6.70
F	70-1148-00	Gold Arabic	\$10.50	\$9.45	\$8.40	\$7.55	\$6.70
G	70-1147-FR	Fancy Roman	\$10.50	\$9.45	\$8.40	\$7.55	\$6.70
H	70-1148-FA	Fancy Arabic	\$10.50	\$9.45	\$8.40	\$7.55	\$6.70



Inserts 102mm (4") Diameter

These inserts have a 61mm (2 3/8") mounting diameter and take a AAA battery (70-3211-00).

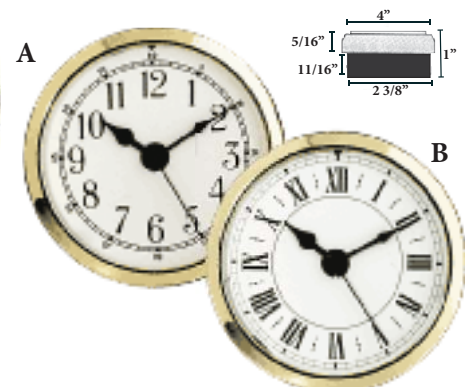

Fig	Cat#	Size	1	2-5	20+
A	70-1178-00	4"	\$12.85	\$11.40	\$9.40
B	70-1181-00	4"	\$12.85	\$11.40	\$9.40



Request free plans to make this clock. Ask for 70-1487-PL

1" Shaker Pegs



Cat# 70-2653-00
.85 Sold 3/pkg

Inserts 70mm (2 3/4")

These 70mm (2 3/4") inserts have a 61mm (2 3/8") mounting diameter (forstner bit 70-3823-00) and take an AAA battery (70-3211-00). You can mix and match for quantity pricing.



Fig	Cat#	Description	QTY 1	2-5	6-19	20-49	50-UP
A	70-1100-08	White Roman	\$10.50	\$9.45	\$8.40	\$7.55	\$6.70
B	70-1100-03	White Arabic	\$10.50	\$9.45	\$8.40	\$7.55	\$6.70
C	70-1100-06	Ivory Roman	\$10.50	\$9.45	\$8.40	\$7.55	\$6.70
D	70-1100-01	Ivory Arabic	\$10.50	\$9.45	\$8.40	\$7.55	\$6.70
E	70-1100-07	Gold Roman	\$10.50	\$9.45	\$8.40	\$7.55	\$6.70
F	70-1100-02	Gold Arabic	\$10.50	\$9.45	\$8.40	\$7.55	\$6.70
G	70-1100-10	Fancy Arabic	\$10.50	\$9.45	\$8.40	\$7.55	\$6.70
H	70-1100-12	Fancy Roman	\$10.50	\$9.45	\$8.40	\$7.55	\$6.70



Request FREE plans to make this wrist watch clock. Ask for 70-1491-PL



Large Inserts 5 7/8", 6 1/4" and 7 7/8"

They have a 3 1/4" mounting diameter (forstner bit 70-3838-00) and takes an AA cell battery (70-3201-00)

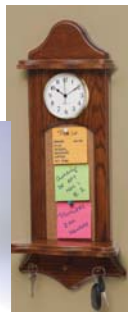

Fig	Cat#	Size	1	2-5	6-up
A	70-1100-20	149mm (5 7/8")	\$34.50	\$30.20	-
B	70-1100-23	149mm (5 7/8")	\$34.50	\$30.20	-
B	70-1100-25	200mm (7 7/8")	\$31.85	\$29.25	\$25.55
C	70-1100-26	149mm (5 7/8")	\$34.50	\$30.20	-
C	70-1100-27	159mm (6 1/4")	\$37.50	\$32.80	-
C	70-1100-28	200mm (7 7/8")	\$41.25	\$36.10	-

Forstner Bits

These bits are made of high carbon steel. They bore clean, precise holes in a variety of woods. Bits up to 7/8" have a 1/4" shaft

Cat.#	Size	Shank	Price
70-3823-00	2 3/8"	7/16" hex	\$16.40
70-3816-00	3"	7/16" hex	\$24.80
70-3838-00	3 1/4"	7/16" hex	\$31.10



Toll Free 1.800.263.3556 • Toll Free Fax 1.800.731.8424 • www.kidder.ca

Prices are subject to change without notice

37mm Inserts in Various Styles

These inserts have a 1 3/8" (35mm) mounting diameter (use forstner bit 70-3813-00) and a 1 7/16" (37mm) outside diameter. You can mix and match for quantity pricing. The battery (70-3214-00) is included

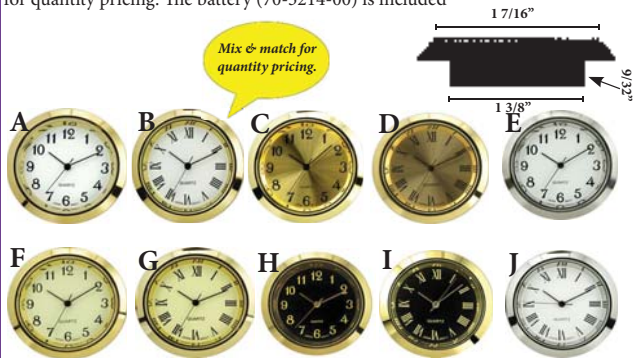

Fig	Cat#	Description	Qty 1	2-5	6-19	20-49
A	70-1152-00	White w/arabic numerals	\$9.95	\$8.95	\$7.95	\$6.95
B	70-1150-00	White w/roman numerals	\$9.95	\$8.95	\$7.95	\$6.95
C	70-1152-GD	Gold w/arabic numerals	\$9.95	\$8.95	\$7.95	\$6.95
D	70-1150-GD	Gold w/roman numerals	\$9.95	\$8.95	\$7.95	\$6.95
E	70-1152-SI	Silver frame w/arabic numerals	\$9.95	\$8.95	\$7.95	\$6.95
F	70-1152-CR	Ivory w/arabic numerals	\$9.95	\$8.95	\$7.95	\$6.95
G	70-1150-CR	Ivory w/roman numerals	\$9.95	\$8.95	\$7.95	\$6.95
H	70-1152-BK	Black w/arabic numerals	\$9.95	\$8.95	\$7.95	\$6.95
I	70-1150-BK	Black w/roman numerals	\$9.95	\$8.95	\$7.95	\$6.95
J	70-1150-SI	Silver frame w/roman numerals	\$9.95	\$8.95	\$7.95	\$6.95



Insert Battery

Cat# 70-3214-00

Qty 1 \$1.60.....2-5 \$1.40....6+ \$1.20

2" Diameter Inserts

These inserts have a gold-tone plastic bezel with decorative waterfall design. The mounting diameter is 1 7/8" (forstner bit 70-3817-00). Battery is included



70-1159-00
White Arabic



70-1158-00
White Roman

Qty	\$ Each
1	\$13.50
2-5	\$12.00
6-UP	\$10.10

Barometer



70mm o.d.
60mm mounting diam.
Cat# 70-3601-00..\$22.75

Hygrometer



70mm o.d.
60mm mounting diam.
Cat# 70-3602-00..\$11.95

Thermometers



70mm o.d.
60mm mounting diam.
Cat# 70-3603-00..\$13.55

Hygrometer



37mm o.d.
35mm mounting diam.
Cat# 70-3619-00..\$9.95



37mm o.d.
35mm mounting diam.
Cat# 70-3618-00..\$7.50

Thermometer Movements

No battery is required for this movement. It can be used indoors or outdoors. Use this movement with one of our dials or create your own unique design. It installs like a regular mini movement and takes standard hands as an indicator. The movement comes with a handy reference dial. It fits in an opening 2 1/4 x 2 1/4.

Cat#	Description	Price
70-3604-NS	3/8" (10mm) Movement	\$6.45
70-3607-NS	5/8" (16 mm) Movement	\$6.45
70-2351-05	7 1/4" Dial	\$4.50

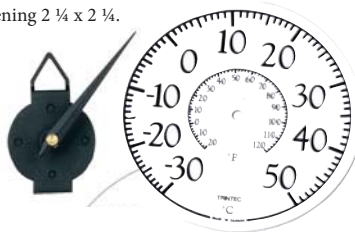

Insert Holder for Desk Set

Make a beautiful desk set with this easy to mount insert holder. It is brass colour and fits the 1 3/8" insert. Mounting screw is included. The unit is 2 5/16" H

Qty	\$ Each
1	\$4.10
2-5	\$3.70
6-19	\$3.50
20-49	\$3.40
50-up	\$3.30



Cat# 70-1104-00 EA

Extra Hardware for Movements

Highlighted hardware is the standard hardware for the mini movements.

\$2.95 10/pkg



Fig	Cat#	Description	Size	Pkg
A	70-2126-00	Rubber Washers	for ALL mov'ts	10
B	70-2124-00	Hex Nuts	5/16" shaft	10
B	70-2121-00	Hex Nuts	7/16" shaft	10
C	70-2119-00	Minute Nuts	for RD Mov'ts	10
C	70-2120-00	Minute Nuts	fro MP & QW Mov'ts	10
D	70-2113-10	Cap Nuts	for MP & QW Mov'ts	10
D	70-2114-10	Cap Nuts	for RD Mov'ts	10
E	70-2115-00	Brass Washers	3/4" x 7/16"	10
E	70-2116-00	Brass Washers	5/8" x 7/16"	10
E	70-2125-00	Brass Washers	7/16" x 5/16"	10



Assorted Hand Packs

CAT.# 70-5412-20
20 /PKG \$26.50

CAT.# 70-5412-50
50 /PKG \$49.50

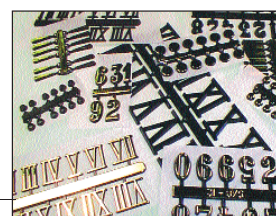

Assorted Numeral Packs

CAT.# 70-5409-20
20 /PKG \$24.50

CAT.# 70-5409-50
50 /PKG \$42.50

3 Dimensional Puzzle Kits

These 3-dimensional (3D) puzzles include pre-cut wooden pieces that push out of the plywood sheets. All kits include assembly diagrams and sandpaper to touch up rough spots. Stain, paint or leave wood natural. Fun and easy project for children ages 6 and up.

The clock kits include one quartz time-only clock movement, hands, and assembly hardware. Requires 1 AA battery, sold separately.



142mm W x 73mm D x 208mm H



220mm L x 100mm W x 242mm H



108 L x 57 W x 350 H mm

Fig	Cat#	Description	Qty 1	2-5	6-up
A	70-14-3310	Alarm Clock Kit	\$17.75	\$15.75	\$13.65
B	70-14-3315	Cuckoo Clock Kit	\$17.75	\$15.75	\$13.65
C	70-14-3320	Grandfather Clock Kit	\$17.75	\$15.75	\$13.65

Design your Own Round Wall Clock Kits

These colourful plastic frames are a great way to make your personalized clock. This kit comes with your choice of coloured frame, clock, hands, second hand, lens and dial backing. Just design your own 6" dial or order one from our collection. It is great for fundraising, gifts, and much more. The frame is 8.5" (216mm) in diameter and requires one AA cell battery (Cat# 70-3201-00).

Qty	Price
1	\$15.20
2-5	\$13.15
6-19	\$12.15
20+	\$10.40



Create clocks with school logos, your favorite sports team, or computer added designs!

- Cat# 70-54-2150 Blue Frame w/clock & hands
- Cat# 70-54-2151 Red Frame w/clock & hands
- Cat# 70-54-2152 Black Frame w/clock & hands
- Cat# 70-54-2153 White Frame w/clock & hands

Slimline Pen Kits

These Slimline kits are the easiest to make and ideal for the beginner as well as advanced turner. The pens use Cross style refills and the pencils all have .7mm trouble-free lead mechanisms. Use bushing 12PKMBUSH3 and drill bit 12-PK-7MM.

Pen Turner's Workbook

Expert turner and teacher, Barry Gross, provides the latest techniques in this revised second edition of his best-selling, "Pen Turner's Workbook." New projects and updated information about pen finishes and materials makes this book a must-have addition to the workshop and pen turner's library.

Cat# 70-1469-00.....\$23.00



Fig	Cat#	Description	Qty1	2-5	6-19	20-49	50-up
A	12-PK-PEN	24kt Gold Plated Pen Kits	\$5.00	\$4.65	\$4.40	\$4.00	-
B	12-PK-PCL	24kt Gold Plated Pencil Kits	\$7.50	\$6.95	\$6.55	\$6.00	\$5.80
C	12PKPENSAT	Satin Pen Kit	\$4.75	\$4.40	\$4.15	\$3.80	\$3.55
D	12PKPCLSAT	Satin Pencil Kit	\$7.25	\$7.05	\$6.65	\$6.10	\$5.70
E	12PKPENA2B	Black Enamel Pen Kit	\$5.25	\$4.85	\$4.60	\$4.20	\$3.95
F	12PKPCLA2B	Black Enamel Pencil Kit	\$8.75	\$8.10	\$7.65	\$7.00	\$6.55

Economical Funline Pen Kits

These Slimline pen kits are easy to make, economical, very popular and great for beginners. The colourful plated finishes will appeal to young and old. Pen kit plating options include Economy Gold, Chrome, Copper, Gun Metal, Satin Gold & Satin Pearl. Use bushing 12PKMBUSH3 and drill bit 12-PK-7MM.

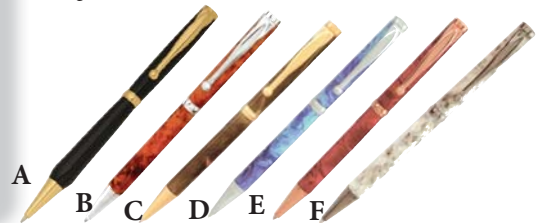

Fig	Cat#	Colour	Qty	\$ Each
A	12PKSLFN24	Gold Plated	1	\$3.55
B	12PKSLFNCH	Chrome Plated	2-5	\$3.35
C	12PKSLFNNG	Satin Gold Plated	6+	\$3.15
D	12PKSLFNPS	Satin Pearl Plated		
E	12PKSLFNCO	Copper Plated		
F	12PKSLFNMG	Gun Metal Plated		

Attractive Desk Pensets

The black pen and funnel is the perfect compliment to your desk set. Use in a design alone or combine with a clock, paper clip, sand timer or other items to make your unique project. The black pen and funnel set is made of high quality plastic with a metal insert for attachment to your project.

Qty	\$/pkg
1	\$48.35
2-up	\$47.00

Cat# 80-4214-ST

Cross Style Pen & Funnel Set

This elegant slimline "Cross" style penset adds a special touch to your desk projects. The pensets are gold and sold individually.



Add a clock to your desk set. See insert holder on page 64.

Qty	Price
1	\$9.90
2-5	\$9.65
6-19	\$9.10

Cat# 80-4204-00

Brass Memo Holder

This is ideal for making your own combination desk pen and memo holder. Screw in base is provided. It has a high quality brass finish. The unit is 4" (10 cm) high.



Qty	Price
1	\$7.10
2-5	\$5.65
6-19	\$5.40
20+	\$5.10

Cat# 80-4241-00

Hanging Devices

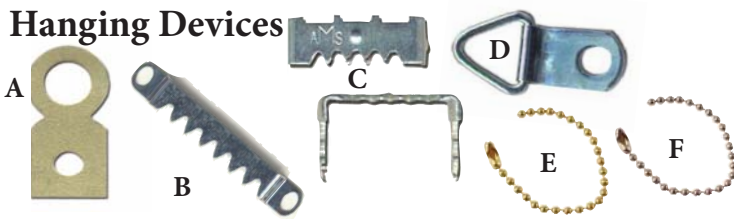

Fig	Cat#	Description	Size	#/Pkg	Price 1	2+
A	70-2602-06	Brass Plated Hanger	13 x 25mm	25	\$1.75	\$1.60
B	70-2602-01	Sawtooth Hanger	70 x 8mm	10	\$1.19	\$1.06
B	70-5402-00	Bulk Sawtooth Hanger	70 x 8mm	100	\$9.30	\$8.00
C	70-2602-02	Self Nail Hanger	25 x 6mm	10	\$1.35	\$1.13
D	70-2602-03	Triangle Hanger	29 x 13mm	10	\$.85	\$.80
D	70-5403-00	Bulk Triangle Hanger	29 x 13mm	100	\$7.50	\$6.00
E	80-4216-00	Brass Key Chain	10cm	100	\$9.95	\$9.45
F	80-4215-00	Nickel Key Chain	10cm	100	\$10.05	\$9.55

Bulk Bead Chain & Connectors

Buy bulk and save costs. This chain comes in spools of 100'. You can purchase connectors to make your own



BULK BEAD 100 ft Spool CHAIN

Cat# 80-4217
Nickel Bead Chain 100' Sp
Cat# 80-4219
Brass Bead Chain 100' Sp

CONNECTORS

Cat# 80-4218
Nickel Connectors 100/pkg
Cat# 80-4220
Brass Connectors 100/pkg

Plastic Piggy Bank Plugs

These 1 1/4" (31 mm) plastic or rubber bank plugs are excellent for your own bank creations. The rubber plugs are used with ceramic or acrylic or any other thin material. The polypropylene plugs are great with wooden banks.

Cat# 80-4281-00....\$7.75 10/pkg



Forstner Bits

These bits are made of high carbon steel. They bore clean, precise holes in a variety of woods. Bits up to 7/8" have a 1/4" shaft.

Cat.#	Size	Shank	Price
70-3820-00	1/4"	1/4" hex	\$3.60
70-3805-00	3/8"	1/4" hex	\$4.05
70-3806-00	1/2"	1/4" hex	\$4.30
70-3807-00	5/8"	1/4" hex	\$4.80
70-3808-00	3/4"	1/4" hex	\$5.00
70-3809-00	7/8"	1/4" hex	\$5.05
70-3810-00	1"	1/4" hex	\$5.60
70-3811-00	1 1/8"	5/16" hex	\$6.45
70-3812-00	1 1/4"	5/16" hex	\$6.55
70-3813-00	1 3/8"	5/16" hex	\$6.85
70-3814-00	1 1/2"	5/16" hex	\$7.65
70-3815-00	1 5/8"	5/16" hex	\$7.80
70-3834-00	1 13/16"	5/16" hex	\$9.55
70-3817-00	1 7/8"	5/16" hex	\$9.70
70-3818-00	2"	5/16" hex	\$10.85
70-3819-00	2 1/8"	5/16" hex	\$11.55
70-3835-00	2 1/4"	7/16" hex	\$13.65
70-3822-00	2 5/16"	7/16" hex	\$14.70
70-3823-00	2 3/8"	7/16" hex	\$16.40
70-3843-00	2 7/8"	7/16" hex	\$21.65
70-3816-00	3"	7/16" hex	\$24.80
70-3802-00	3 1/8"	7/16" hex	\$28.30
70-3838-00	3 1/4"	7/16" hex	\$31.10
70-3833-00	3 3/4"	7/16" hex	\$32.50



Rubber Bumpers

These self-adhesive slip resistant pads are excellent for finished projects. Each rubber bumper is 3/8" x 1/8" (10 mm x 3 mm, 56/pad. Available in clear, black, & white.



Clear		Black & White	
Qty	\$ Pad	Qty	\$ Pad
1	\$10.15	1	\$8.45
2-5	\$9.65	2-5	\$8.00
6-19	\$6.95	6-19	\$7.60
20+	\$8.60	20-49	\$7.20
		50+	\$6.90

Felt Bumpers

These self-adhesive dark green bumper pads are ideal for the bottom of your projects to protect table tops. They are 3/8" in diameter and 1/32" thick. They have 100 per sheet

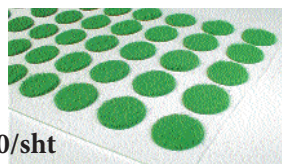

Qty	\$/SHT
1	\$1.75
2+	\$1.69

Cat.# 80-4271-00 100/sht

Breadknife Blades



Cat# 19-3031-HK
Blade 10 1/2" x 5/8" wide
(267 mm x 10 mm)

Qty	\$/Blde
1	\$5.05
2-5	\$4.80
6-19	\$4.35
20+	\$4.05

Plans breadknife
Cat.# 19-3031-PL Plans *
(on request only, one per order)



EnviroTex Epoxy Coating *The Original High-Gloss Polymer Coating*



The highest quality product on the market today. It is a wonderful preservative for any wood surface. It provides a rich glossy finish to protect and beautify for years. It can be used on almost any surface. One coat equals 50 coats of varnish.

Cat#	Size	Coverage	1	2+
34-2007	4 oz (118 ml)	1 sq.ft. (.092 sq.m.)	\$13.90	-
34-2008	8 oz (236 ml)	2 sq.ft. (.185 sq.m.)	\$19.50	-
34-2016	16 oz (473 ml)	4 sq.ft. (.371 sq.m.)	\$32.15	-
34-2032	32 oz (946 ml)	8 sq.ft. (.743 sq.m.)	\$51.00	-
34-2064	64 oz (1,861 l)	16 sq.ft. (1.48 sq.m.)	\$96.00	-
34-2128	1 Gn (3.78 l)	32 sq.ft. (2.92 sq.m.)	\$155.50	-
34-1188-2G	2 GN (7.56l)	64 sq.ft. (5.84 sq.m.)	\$230.00	\$216.50



Cups, Paddles, & Brushes

Fig	Cat#	Description	1	2-5	6-19	20-49	50+
A	34-1011	Brushes	\$.32	\$.28	\$.27	\$.26	\$.24
B	34-1010	Cups	\$.95	\$.90	\$.75	-	-
C	34-1013	Paddles	\$.10	\$.08	\$.06	\$.04	\$.03

Vinyl Gloves

Vinyl gloves offer a high value, dependable for those allergic to natural latex. Appropriate for short term and routine tasks involving minimal stress, Alliance vinyl gloves offer excellent tactile sensitivity which is further enhanced by their smooth surface. They are sold 100/box



Qty	\$/Kit
1	\$9.95
2-5	\$8.45
6+	\$7.40

Cat# 70-3419-00 Large
Cat# 70-3420-00 Medium
Cat# 70-3421-00 Small

How to Figure out Coverage Amount

Circles & Ovals or Clock Blanks
12" x 12" - 144 sq.in.

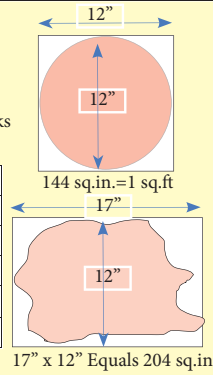

8 oz (236 ml)	2 sq.ft. (.185 sq.m.)
16 oz (473 ml)	4 sq.ft. (.371 sq.m.)
32 oz (946 ml)	8 sq.ft. (.743 sq.m.)
64 oz (1,861 l)	16 sq.ft. (1.48 sq.m.)
1 Gn (3.78 l)	32 sq.ft. (2.92 sq.m.)
2 GN (7.56l)	64 sq.ft. (5.84 sq.m.)

17" x 12" Equals 204 sq.in.

EX-88 Premium Epoxy Coating

EX-88 is an extremely clear, tough, high gloss surface coating formulated to produce a deep glass like appearance in a single layer on a sealed surface. EX-88 has an extended "open time" which allows up to 30 minutes in the mixing container at 70° F and up to one hour working time on the surface being coated. EX-88 is waterproof, heat & alcohol resistant. Used on restaurant table & bar tops for over 20 years.



Longer working time

Qty	Price
1	\$230.00
2+	\$216.50

Cat.# 34-1188-2G
2 Gallon Kit

EX-74 Outdoor Epoxy Coating

EX-74 is an extremely clear, tough, high gloss surface coating formulated to produce a deep glass like appearance in a single layer on a sealed surface. EX-74 has been formulated for improved UV resistance to reduce yellowing and surface degradation from UV exposure. EX-74 has an extended "open time" which allows up to 30 minutes in the mixing container at 70° F and up to one hour working time on the surface being coated. EX-74 is waterproof, heat & alcohol resistant.



UV Inhibitors

Qty	Price
1	\$232.00
2-19	\$219.50
20+	\$213.00

Cat# 34-1174-2G
2 Gallon Kit

Clear Polyester Casting Resin

Castin/Craft Clear Polyester Casting Resin with Catalyst: Resin casting is an exciting and fun craft that allows you to embed or encase almost any object in crystal clear plastic. Coins, shells, rocks, dried flowers, butterflies and insects are just a few of the examples of embedment possibilities. This convenient new package includes catalyst in a clear bubble top cap.

Water Clear

Cat#	Size	1	2-5
52-34016	16 oz	\$37.05	-
52-34032	32 oz	\$52.00	-
52-34128	128 oz	\$137.00	\$120.00



EasyCast Low Odour Casting Resin

EasyCast is a reactive clear casting epoxy. It's solvent free and low odor. It can easily be colored, tinted or combined with fillers to create faux granite or metallic castings. These characteristics make it ideal for casting and embedding up to 6 ounces (maximum) per pour. Due to heat build up and discoloration, do not attempt to cast more than 6 ounces at one time. For larger casts, use Castin/Craft Polyester Casting Resin.



Cat#	Description	Price 1	6+
34-33008	EasyCast Epoxy 8oz	\$18.75	-
34-33016	EasyCast Epoxy 16oz	\$31.00	-
34-33032	EasyCast Epoxy 32oz	\$51.00	-
34-33128	EasyCast Epoxy 128oz	\$156.00	\$136.50

Toll Free 1.800.263.3556 • Toll Free Fax 1.800.731.8424 • www.kidder.ca

Prices are subject to change without notice

Parts for All Your Lamp Making Needs Parts for All Your Lamp Making Needs



Fig	Cat#	Description	Pkg	1
A	80-4429-WT	White In-Line Switch	ea	\$1.32
B	80-4429-BN	Brown In-Line Switch	ea	\$1.43
C	80-4430-WT	White Safety Plug	ea	\$1.20
D	80-4430-BN	Brown Safety Plug	ea	\$1.53
E	80-4401-00	8" Detachable Harp (Finial Extra)	ea	\$2.70
E	80-4402-00	10" Detachable Harp (Finial Extra)	ea	\$2.55
E	80-4403-00	12" Detachable Harp (Finial Extra)	ea	\$3.00
F	80-4405-00	Finial cap	ea	\$1.30
G	80-4424-00	Candelabra Socket	ea	\$2.35
H	80-4421-00	Hex lock Nuts	25	\$4.05
I	80-4423-00	Lock Washers for 3/8" Pipe	50	\$1.23
J	80-4422-00	Steel Washers for 3/8" Hole	50	\$9.25
K	80-4409-00	2" Threaded Nipple 1/8" ips.	50	\$16.35
L	80-4408-00	1 1/2" Threaded Nipple 1/8" ips	50	\$15.90
M	80-4407-00	1" Threaded Nipple 1/8" ips	50	\$12.40
N	80-4406-00	3/4" Threaded Nipple 1/8" ips	50	\$5.00
O	80-4410-00	Keyless Lamp Socket* without switch	ea	\$3.00
P	80-4426-00	Lamp Socket with on/off	ea	\$3.60
Q	80-4434-00	Phenolic Lamp Socket with Pull Chain	ea	\$3.65
R	80-4414-00	9" Steel Pipe Threaded Both Ends 1/8"ips	ea	\$1.44
S	80-4415-00	15" Steel Pipe Threded Both Ends 1/8"ips	ea	\$2.70
T	80-4411-00	36" Steel Pipe Threaded 1/8"ips	ea	\$5.35

See www.kidder.ca for quantity discounts

6' Lamp Cord w/Plug



These 6' (152 mm) lamp cords have a moulded plug and 3/4" stripped ends.

Qty	Price
1	\$4.45
2-5	4.20
6+	\$3.85

Cat# 80-4428-WT - White
Cat# 80-4428-GD - Gold

6' Lamp Cord w/Plug and Inline Switch



These 6' (152 mm) lamp cords have a moulded plug and inline switch with 3/4" stripped ends.

Qty	Price
1	\$4.70
2-5	\$4.25
6-19	\$4.00
20+	\$3.90

Cat# 80-4448-WT - white
Cat# 80-4448-BN - brown

Complete Lamp Kit

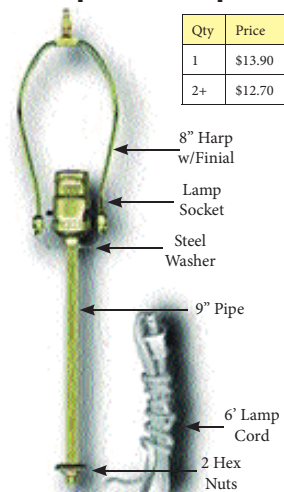

Qty	Price
1	\$13.90
2+	\$12.70

Cat# 80-44SPECL

If you don't see something you are looking for please give us a call.

Giant Clothes Pin Spring

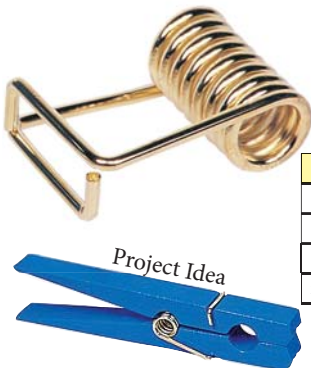

Qty	\$/ea
1	\$2.10
2-5	\$1.87
6-19	\$1.77
20+	\$1.66

Make a giant clip with this brass spring. It measures 2" x 1 5/16" x 3/4".

Cat# 80-4240-00

Mug and Shaker Pegs

3 3/8" (9cm) with a 1/2" pin size



Qty	\$ ea
1	\$.50
2-5	\$.46
6-19	\$.44
20-49	\$.42
50+	\$.39



A) Mug Pegs Cat# 70-2656-00
B) Shaker Pegs Cat# 70-2655-00

Professional Wood Burning

This woodburner features a lightweight, thin varnished wooden handle that stays cool because the heating element is directly under the tip. This tool reaches 850 °F in under two minutes and is available with a wide variety of specialty tips.



Features That Work:

- * Great for woodburning decoys
- * Detailing and design
- * Handle stays cool
- * 14 specialty tips to choose from



Specifications

Woodburner is 6 3/4" long overall. It has a 3 5/8" long tapered varnished wooden handle, and a 1 1/2" long strain relief leading to a 64" long power cord. The shaft is .140" dia. by 1 9/16" long. The tips are 3/16" outside diameter by approx. 2" long. The tools operate on 115 Volts.



Cat#	Description	Price
80-4850-00	Woodburning Tool	\$71.50
80-4850-03	Standard Tip	\$12.50
80-4850-01	Needle Tip	\$12.50
80-4850-02	Blank Tip	\$12.50
80-4850-04	Feather	\$12.50
80-4850-08	Dial-Temp Control	\$59.00



Multipurpose Tool

This tool opens up a whole world of creativity for decorating many articles such as wooden items, picture frames, leather articles, furniture, cabinets, jewelry and much more. You can purchase an extra set of wood burning/solder tips or the decorator tips.



Features

- 30 watt tool
- Maximum temperature of 1,050 f (565 ° C)
- Stay cool grooved handle for comfort

Kit Includes:

Includes 3 Soldering Tips, 4 Woodburning Tips, 2 Cutting/Fusing Tips plus solder and handy stand and case.
Standard Replacement Tips
Cat.#80-4832-08.....\$7.05 2/pkg

Cat# 80-4832-00.....\$40.80

Decorator Branding Kit



This tool opens up a whole world of creativity for decorating many articles such as wooden items, picture frames, leather articles, furniture, cabinets, jewelry and much more. You can purchase the wood burning, solder tips or the decorator tips.

Features

- 30 watt tool
- Maximum temperature of 1,050 f (565 ° C)
- Stay cool grooved handle for comfort

Kit Includes

Includes a 30watt tool, 7 stylized decor brands plus 2 freehand tips.



7 Stylized Decor Brands & 2 Freehand tips

Cat# 65-L30DBK.....\$56.50

Order extra tips Cat#80-4832DT1 \$19.85

Button Maker



Design graphics on your computer then make your own buttons at home or in your classroom! It makes 2 1/4" (57 mm) buttons easily.

- Fund Raising
- Souvenirs
- Awards
- Photographs
- Craft projects

*Email info@kidder.ca to inquire about other size options of Button Maker and Buttons.



Cat#15-225-PBM

Button Maker..\$446.00

This includes free parts to make 25 buttons.



BUTTONS

Cat# 15-225-BT

Package of 25 button assemblies. One package is included with the button maker. Please see right for bulk buttons.

Qty	Price
1	\$6.95
2-5	\$6.75
6-19	\$6.40
20+	\$4.55

Adjustable Rotary Circle Cutter



This circle cutter provides a low-cost method to cut circular button graphics with accuracy. The cutter comes with two interchangeable plastic centering templates, pre-cut for 1" button graphics (1.313"). A cutting plate is also included and protects surfaces as the rotary cutter "crush cuts" the graphic. Depending on thickness, multiple graphics may be cut at one time.

CAT# 15-27500.....\$174.50

Bulk Buttons



Cat# 15-5401

500 Button Pkg
\$90.00, 2+ \$80.00

Cat# 15-5402

2000 Button Pkg
\$240.00, 2+ \$225.00

Circle Cutter



Cut a 2 5/8" circle easily with this cutter. Ideal for button maker..
Cat# 15-2625-CP....\$293.00

Toll Free 1.800.263.3556 • Toll Free Fax 1.800.731.8424 • www.kidder.ca

Prices are subject to change without notice

ABRASIVE CLEANER.....	29	CHERRY PICKER HYDRAULICS KIT.....	39	EXCAVATOR KIT.....	39
ACRYLIC BALLS, DOMES & CUBES.....	53	CHIME MOVEMENT.....	60	EYE SCREWS.....	6,8
ACRYLIC BENDER.....	54	CIRCLE CUTTER FOR BUTTON MAKER.....	69	EYELETS.....	8
ACRYLIC GLUES & CEMENTS.....	52	CIRCUIT'S SERIES/PARALLEL.....	20	FAHNSTOCK CLIPS.....	16
ACRYLIC HINGES.....	53	CLAMPS (C-TYPE).....	30	FAN.....	22
ACRYLIC ROD, TUBING, SQUARE ROD.....	53	CLEAR CASTING RESIN.....	67	FELT BUMPERS.....	66
ACRYLIC SHEETS & OFFCUTS.....	51	CLIPS ALUMINUM AND PLASTIC.....	17	FI (FORMULA 1) SUPPLIES.....	6
ADHESIVE TAPE.....	28,38	CLOCK DIALS.....	62,63	FILES.....	29
ADJUSTIBLE WRENCH.....	31	CLOCK HANDS.....	60,61	FIRST AID KIT CLASS SIZE.....	35
AIR MOTOR CAR KIT.....	7	CLOCK KITS.....	65	FISKERS HANDS DRILL.....	29,32
AIR ROCKET CLASS PACK.....	45	CLOCK MOVEMENTS.....	59,60	FITUPS.....	63
ALLIGATOR CLIPS & LEADS.....	16,17	CLOCK NUMBERS.....	62	FLASKS.....	48
ALTERNATIVE ENERGY KITS.....	21,22	CLOCK PLANS.....	63	FLIGHT.....	43-45
ALTITUDE FINDER.....	43	CLOTHESPINS.....	10,38,68	FOAM TAPE.....	28,38
ANGLE CUTTER (KIDDER CUTTER).....	28,31	CLOTHESPINS (GIANT PROJECT).....	68	FORMULA 1.....	6
APPLICATOR FOR PLEXWELD F.....	52	CO2 CARTRIDGES.....	4	FORSTNER BITS.....	66
APRON (DENIM WORK).....	35	CO2 ELIMINATOR LAUNCHER.....	6	FRICITION RODS.....	20
ARBOUR ADAPTER.....	53	COATING CLEAR EPOXY.....	67	GEAR BOX MOTOR.....	15
ART STRAWS.....	27	COMPACT DRILL.....	32	GEAR JIGS/SETS.....	15
AXLE GUSSETS.....	10	COMPASS GEOMETRY SET.....	37	GEAR RACK.....	15
AXLE HOLDERS.....	10	CONDUCTIVITY TESTER.....	20	GEARS.....	15,17,19,42
AXLES.....	4,6,12,13,27	CONNECTORS HYDRAULIC.....	40	GENERATOR CLASS PACK.....	21
BALLOON HELICOPTOR CLS.PK.....	44,50	CONSTRUCTION PAPER COLOUR.....	36	GIANT CLOTHES SPRING.....	68
BALLOON JET CAR KIT.....	7	CONTACT CEMENT.....	28	GLASS BEAKERS.....	48
BALLOONS.....	36	COPING SAW.....	32	GLASSES SAFETY TYPE.....	35
BALSA CAR BLANK.....	4	COPPER ELECTRODE.....	20	GLIDER KIT.....	44
BALSA STRIPS & SHEETS.....	25, 27 & 39	COPPER FOIL.....	16	GLOVES.....	35
BALTIC BIRCH PLYWOOD SHEETS.....	39	COPPER WIRE.....	16	GLUE (WOOD GLUE).....	28
BAR MAGNETS.....	23	CORDLESS DRILL.....	32	GLUE GUN.....	28,31
BAROMETER.....	64	COROPLAST, CORROGATED PLASTIC.....	27,51	GLUE HOLDERS CUPS.....	28
BASSWOOD BLANK CO2.....	4	CRAFT STICKS & PROJ.BOOK IDEAS.....	27,56	GLUE STICKS.....	28,31
BASSWOOD CUTTER.....	28	CRAZY GLUE.....	28	GOGGLES.....	35
BASSWOOD JOINTER.....	30	CREPE ABRASIVE CLEANER.....	29	GRADUATED CYLINDERS.....	48
BASSWOOD SHEETS/STIPS.....	25,27,39	CROSS STYLE PENS.....	65	GUSSETS.....	10,27
BATTERIES.....	18,64	CUBES (DENSITY).....	50	HACKSAW & BLADES.....	30
BATTERY HOLDERS AND TESTER.....	18	CUTTING MAT.....	28,31	HALOGEN LIGHT.....	21
BEAD CHAIN.....	66	CUTTING TOOL.....	30	HAMMER (REGULAR AND MINI).....	31
BEAKERS.....	48	DA VINCI KITS.....	26	HAND DRILL.....	32
BEARINGS STRAWS, METAL EYELETS.....	4,8	DECALS FOR MODEL CARS.....	4,13	HAND GENERATOR KIT.....	21
BENCH HOOKS.....	30	DECORATOR BRANDING TOOL.....	69	HAND PROTECTORS.....	61
BEVELED GEARS.....	15	DELTA DARTS.....	44	HANDS (CLOCK).....	60,61
BIRCH PLYWOOD.....	39	DENSITY BLOCKS/CUBES.....	50	HANDS ON TEACHING BOOKS.....	56-58
BLADE PITCH PROTRACTOR.....	22	DESIGN & MAKE FOLIOS BOOKS.....	57	HANGERS.....	66
BOOKS.....	11,13,18,33,40,43,56, 57,58	DESIGN YOUR OWN CLOCKS.....	65	HARDWARE (CLOCK).....	64
BOROSILICATE GLASS BEAKERS.....	48	DESK PENS SETS.....	65	HARPS (LAMP).....	68
BOTTLE ROCKET LAUNCHER.....	45	DIALS CLOCK.....	62	HEADLESS MATCH STICKS.....	27
BRASS BEAD CHAIN/CONNECTORS.....	66	DIGITAL CALIPERS.....	29	HEAT GUN.....	53
BRASS FASTENERS 1".....	27,36	DIGITAL MULTI METER.....	18	HELICOPTER KIT.....	44,50
BRASS HANGER.....	66	DOLLAR PLUS ITEMS.....	36-38	HEX MASS WEIGHT SET.....	50
BREADKIFE BLADE.....	66	DOMES CLEAR ACRYLIC.....	53	HIGH TORQUE MOVEMENT.....	60
BREAK SWITCH.....	16	DOUBLE SIDED TAPE.....	28,38	HINGES (ACRYLIC).....	53
BRIDGE KITS.....	26	DOWEL WOOD.....	8,22,27	HIP ROOF KIT.....	25
BRUSHES.....	37,67	DRAGSTER CO2 SUPPLIES.....	4,5	HOBBY FILE.....	29
BUFFING COMPOUND.....	53	DRAGSTER LAUNCHER & TIMER.....	5	HOLE PUNCH.....	29,32
BUFFING WHEELS.....	53	DRILL BITS.....	32,42	HOOK AND LOOP FASTENERS.....	38
BULB HOLDER.....	16	DRILL PRESS VISE.....	30	HOOK UP WIRE.....	16
BULBS (LIGHT).....	16	DRIVE BANDS.....	14,36	HOOKED MASS WEIGHT SET.....	50
BULK WHEELS.....	4,10	DUAL HAND MAGNF. LENS.....	49	HOTSHOT LAUNCHER.....	5
BULLET TRAIN KIT.....	24	EAR PLUGS ,EAR MUFF.....	35	HOUSE FRAMING KIT.....	25
BUMPERS CLEAR & BLACK.....	66	EARTH MAGNETS.....	23	HOVERCRAFT CLASS PACK.....	50
BURETTE CLAMP.....	49	EASYCAST RESIN.....	67	HUB (WINDTURBINE).....	22,42
BURNER BUTANE FOR LABS.....	49	EDGE SCRAPER.....	52	HYDRAULIC KITS & SUPPLIES.....	39,40,41
BUSHINGS.....	14,15	ELASTIC CAR KIT.....	7	HYGROMETER.....	64
BUTTON MAKER SUPPLIES.....	69	ELBOW CONNECTORS.....	40	IGNITERS.....	43
BUZZERS (ELECTRIC).....	16	ELECTRIC CAR KIT.....	7,12,14	IN-LINE SWITCH FOR LAMPS.....	68
CO2 DRAGSTER SUPPLIES.....	4,5	ELECTRIC MOTOR GENERATOR.....	17	INSERT HOLDERS.....	64
CO2 ELIMINATOR SUPPLIES.....	6	ELECTRIC PAINT.....	19	INSERTS MINI CLOCK.....	64
CABLE TIES.....	29	ELECTRICAL TAPE.....	20	IRON FILLINGS.....	23
CAMS.....	11	ELECTRICITY KIT.....	20	JINX JOINTERS.....	29
CAR BODY.....	4	ELECTROMAGNETISM KIT.....	23,24	JITTERBUG KIT.....	17
CAR KITS.....	7	ELECTRONIC SCALE.....	5	KALEIDOSCOPE.....	38
CARD STOCK/CARDBOARD WHEELS.....	7,11	EMX-2 STRIP HEATER.....	54	KEY CHAIN GLD & NI.....	41,68
CARPENTER GLUE.....	28	ENGBOXES.....	10,14,19	KEY RINGS.....	68
CARTRIDGES CO2.....	4	ENGINES (ROCKET TYPE).....	43	KIDDER KUTTER.....	28,30,31
CASTING RESIN SUPPLIES.....	67	ENGRAVING STOCK.....	51	KIDDER SCOPE.....	47
C-CLAMPS.....	30	ENVIROTEX EPOXY COATINGS.....	67	KNIFE SWITCH.....	16
CD AXLE HUB.....	8,10	EPOXY COATING.....	67	LAB COAT.....	35
CEMENT SOLVENT.....	52	ERLENMEYER FLASKS.....	48	LACQUER SPRAY.....	63
CERAMIC MAGNETS.....	23	EX-74.....	67	LAMP CORD/SOCKET/SHADE.....	66
CHEMISTRY SET.....	49	EX-88.....	67	LAMP SUPPLIES.....	66

LAUNCHER CO2	5	PLASTIC SCRATCH REMOVER.....	52	STICK CUTTER.....	32
LEATHER PUNCH	30	PLASTIC SHEETS	51	STOOL (METAL).....	34
LED FLASHLIGHT	38	PLASTIC SPOONS	37	STOPCOCK 2-WAY & 3-WAY	40
LED LIGHTS ASSORTED	16,17,20	PLATFORM LIFTER KIT	39	STRAIGHTLINE BENDERS	54
LIFT BRIDGE KIT	26	PLEXWELD F CEMENT	52	STRAW ROCKETS/ LAUNCHER	45
LIGHT BULBS SCREW ASST'D VOLTS	16	PLIERS	31	STRAWS	4,6,36,37,45
LOW TEMP GLUE GUN.....	28,31	PLYWOOD BIRCHPLY	39	STRING (COTTON).....	36
LYRE PENDULUM ATTACHMENT	59	POLYSTYRENE SHEETS	55	STRING (NYLON)	8,14,50
MAGLEADS	20	POP BOTTLE LAUNCHER	45	STRIPHEATER	54
MAG-LEV SUPPLIES/CAR KIT	9,23,24	POPSICLE STICKS	9,27	STRUCTURE KITS.....	25
MAG-LEV TRACK.....	9,23	POWER CONTROL VARIABLE	18	SUPER GLUE.....	28
MAGNET MOTOR KIT	24	PREPARED SLIDES.....	49	SUPER WHEELS.....	8,10,19
MAGNETIC LEVITATION KIT.....	24	PRIMARY VACUUM FORMER.....	55	SWING BRIDGE KIT	26
MAGNETS.....	23	PROPELLER CAR KIT	7	SWITCH ELECTRIC LOW VOLTAGE.....	16
MAGNIFIER	38	PROPELLERS	9,17,21,44	SYRINGES HYDRAULIC.....	40
MAKERS SPACE STATIONS.....	34	PULL METERS.....	50	T-SHIRT PRESS.....	55
MAKERS SPACE TOOLS/SUPPLY	33,34	PULLEY BLOCK.....	14,50	TABLE PROTECTOR.....	32
MANUAL HAND DRILL	32	PULLEY CORD.....	14,50	T-CONNECTORS HYDRAULICS	40
MARBLES (GLASS).....	38	PULLEYS	14,17,19	TEACHERGEEK PRODUCTS	41,42
MARKERS (CLOCK).....	59,62	PUSH METERS.....	50	TELESCOPES	46
MASS WEIGHT SET	50	PUSH SWITCH.....	16	TEST TUBE HOLDER/CLAMPS	48
MASS WHEEL (OFF CENTRED).....	11,17	PUZZLE CLOCK KITS	65	TEST TUBES.....	48
MATCH STICKS	27	QUARTZ CLOCK MOVEMENTS.....	59,60,63,64	THERMOFORMER.....	55
MDF WHEELS	10,11	RARE EARTH MAGNETS.....	23	THERMOMETER MOVEMENTS.....	64
MEASURING TAPE.....	29,36	RAY BOX.....	47	THERMOMETERS LAB TYPE	48
MEMO HOLDER.....	65	RAZOR SAW.....	28,31	THICK CARD WHEELS	10,11
MES BULBS	16	REAR SLICKS DRAGSTER WHEEL	4,10	THICKENED CEMENT	28,52
METAL DIALS (CLOCKS).....	62	RECOVERY WADDING ROCKETRY	43	THREADED NIPPLE LAMP MAKING	68
METAL RULER.....	30,36	REED SWITCH.....	16	THREADED PIPE LAMP MAKING.....	68
MICRO SWITCH.....	16	REMOTE CONTROLLER.....	12,13,43	THUMB TACKS.....	36
MICROSCOPE.....	49	RESOURCE MATERIAL	20,56-58	TIMER (CO2 DRAGSTER)	5
MICROSCOPE SLIDES	49	RETORT STAND	49	TOGGLE SWITCH.....	16
MINUTE NUT DRIVER.....	59	RIGHT FLYER.....	44	TONGUE DEPRESSORS	9,27
MIRROR & MIRROR SHEETS.....	47,51	ROBOTIC ARM.....	40	TOOLS.....	28-32
MITRE BOX	28,30	ROCKET LAUNCHER	43,45	TOWER KIT	25
MIXING CUPS.....	37,67	ROCKET MOTORS.....	43	TOWER KIT	25
MOBLE TOOL CART	34	ROCKETRY SUPPLIES.....	43,45	TRACK SCALEXTRIC.....	12
MODELING CLAY.....	37	ROTATIONAL VISE	29	TRACKED VEHICLE CHASSIS.....	13
MOTOR CAR KITS.....	7,14	ROUND DIALS	62	TRACTION BANDS.....	10
MOTOR GEAR	15	RUBBER BAND WINDER.....	44	TREBUCHET KIT	26
MOTOR MOUNTS	17	RUBBER BANDS	14,36,44	TRIANGLE HANGER.....	66
MOTOR PULLEY	15,17,22	RUBBER BUMPERS	66	TRIPLE BEAM BALANCE	50
MOTORS.....	9,17,22	RUBBER STOPPERS	48	TRONIX LAB BOOKS.....	20
MOUSETRAP RACING, CAR KIT	8,58	RULER	30,36	TRUSS ROOF KIT	25
MUDWATT SUPPLIES.....	46	SABRE SAW BLADES.....	52	TUBING (CLEAR VINYL)	40
MUG PEGS.....	68	SAFETY GLASSES.....	35	TUBLUAR CHIME MOVEMENT	60
MULTI METER.....	18,22	SAFETY SNIPS.....	30,31	TWIN MOTOR GEAR BOX.....	15
MULTI-CORE WIRE RED/BLK	16	SANDING SPONGES	29	U-SHAPED MAGNETS.....	23
MULTI-TRAY HEATING SYSTEM.....	54	SANDPAPER	29	UTILITY KNIFE.....	30
NEEDLE FILES.....	29	SAWS	28,30	UV BEADS	47
NEWTON PUSH PULL METERS	50	SAWTOOTH HANGER.....	66	VACUUM FORMER	12,55
NO CO2 DRAGSTER SUPPLIES	6	SCALE (ELECTRONIC WEIGHT).....	5	VALVES HYDRAULIC AND AIR.....	40
NUMBERS (CLOCK).....	62	SCALEXTRIC FOR SCHOOLS	12	VERTICAL HAND DRILL	32
NUT MINUTENUT DRIVER/TIGHTENER.....	59	SCHOOL CLOCK.....	60	VINYL GLOVES.....	35
NYLON STRING (PULLEY CORD).....	14	SCISSOR LIFT KIT	39	VINYL TUBING.....	40
OFFCUTS (ACRYLIC).....	51	SCREW EYES	4,6,8,10	VISE (ROTATIONAL & DRILL PRESS)	30
OLFA CUTTER (PLASTIC)	52	SCREWDRIVER	18,31	VOLCANO KIT	46
ON/OFF LEVER (MUSIC MVNT)	67	SECOND HANDS (CLOCKS)	60,61	VOLUMETRIC FLASKS	48
OPTICS SUPPLIES.....	47	SELF-ADHESIVE CLIP MOUNTS.....	17,40	WASHERS	4,6,10,68
O-RINGS (RUBBER)	10,14	SERIES/PARALLEL CIRCUITS	20	WATER PUMP WIND GENERATOR	22
PADDLES (MIXING TONGUE DEPR)	9,27,63	SET & FORGET CLOCK	60	WEATHER INSTRUMENTS	64
PAINT BRUSHES.....	37	SHAKER PEGS.....	68	WEIGHTS HOOKED & HEX MASS SETS	50
PAPER DRILL & CUTTER.....	29	SIMPLE GEARBOX MOTOR.....	15	WESTMINSTER CHIME MOVEMENT	60
PAPER STRAWS	27	SLIDE SWITCH	16	WHEELS.....	4-6,10-13,19
PARTS ORGANIZER	17	SLIDES MICROSCOPE	49	WIND ENERGY	22,41
PEN SETS	65	SNAP CIRCUITS	21	WINDER (RATIO 5 TO 1).....	44
PEN TURNING KITS	65	SOLAR CAR KIT/ CELLS.....	7,21	WIRE ASSORTED COLOURS	16,18
PENDULUM CLOCKS	59,60	SOLAR POWER	21	WIRE STRIPPER.....	18
PERISCOPE KIT	47	SOLAR PROPELLER	17,21	WIZARD ROCKET KITS.....	43
PETRI DISHES	49	SOLAR SYSTEM	46	WOOD BURNING MULTI PURPOSE.....	69
PIANO HINGES (ACRYLIC).....	53	SOLDER	18	WOOD GLUE	28
PIGGY BANK PLUGS.....	66	SOLDERING GUN & IRON	18	WOOD TURNING (PENS)	65
PINECAR RACER SUPPLIES & BOOKS	13,57	SPHERES CLEAR ACRYLIC.....	53	WOODEN CAMS.....	11
PIPE CLEANERS	37	SPOOLS (PLASTIC COLOURED).....	10	WOODEN CLOCK KITS.....	65
PIPETTE.....	48	SPRINGS (ASS'TD BOX)	29	WOODEN SKEWERS/STICKS	12,38
PLANE KITS.....	44	SQUARE MIRROR.....	38,47	WORM GEARS.....	15
PLANE WHEELS.....	44	SQUARE ROD CLEAR ACRYLIC.....	53	WORM GEAR CAR KIT	7
PLASTIC CEMENT.....	52	START PIN ASSEMBLY CO2	5	WRENCH (ADJUSTABLE)	31
PLASTIC HEAT BENDER.....	54	STEEL AXLES	4,6	ZINC STRIP ELECTRODE	20
PLASTIC POLISH.....	53				

KIDDER

DESIGN TECHNOLOGY
AND SCIENCE EDUCATION



ENGbox™



Pulley & Gears Cat# ENGBOX-PG

Wheels Cat# ENGBOX-W

Electricity Cat# ENGBOX-E

Kidder Mfg. Co. Ltd.
#3-39 Glen Cameron Road
Thornhill, ON
L3T 1P1

Science & Technology Department

Woodworker